

**FAG****UCF216**

Flanged housing unit

Schaeffler ID:
0812182060000

Flanged housing unit UCF

Technical information

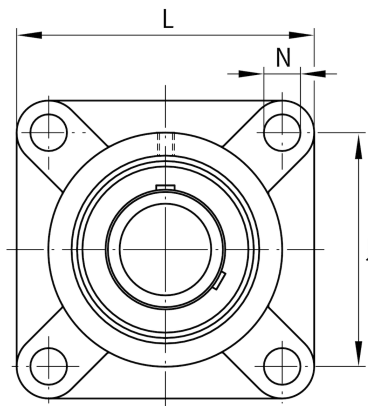
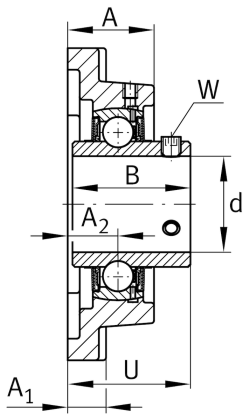
**Dimensions**

A	58 mm	Height housing
A ₁	24 mm	Thickness of flange
A ₂	34 mm	Distance raceway
B	83,3 mm	Width
Q	M6	Connection thread lubrication
	7,4 kg	Weight

Main Dimensions & Performance Data

d	80 mm	Bore diameter
L	208 mm	Flange width
U	83,3 mm	Total height unit
C _r	76.000 N	Basic dynamic load rating, radial
C _{0r}	54.000 N	Basic static load rating, radial
C _{ur}	2.190 N	Fatigue load limit, radial

Mounting dimensions

J	165 mm	Distance fixing bore
N	23 mm	Fixing bore
N ₁	165 mm	Distance fixing bore
n	4	Number of screwing holes

Additional information

	1	Number of housings
	F216	Housing
	UC216	Bearing designation