

**FAG****UCF213**

Flanged housing unit

Schaeffler ID:
0812167260000

Flanged housing unit UCF

Technical information

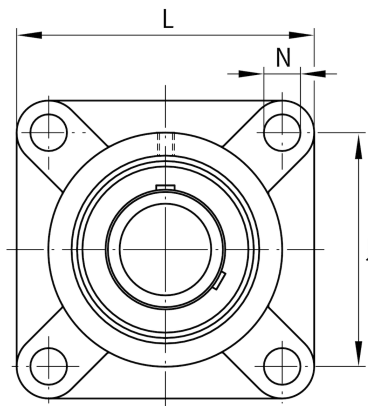
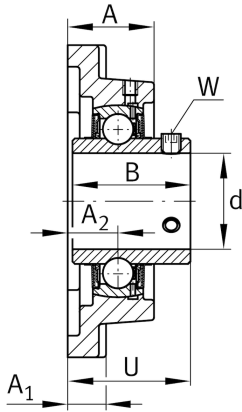
**Dimensions**

A	50 mm	Height housing
A ₁	20 mm	Thickness of flange
A ₂	30 mm	Distance raceway
B	69,7 mm	Width
Q	M6	Connection thread lubrication
	4,9 kg	Weight

Main Dimensions & Performance Data

d	65 mm	Bore diameter
L	187 mm	Flange width
U	69,7 mm	Total height unit
C _r	61.000 N	Basic dynamic load rating, radial
C _{0r}	40.000 N	Basic static load rating, radial
C _{ur}	2.090 N	Fatigue load limit, radial

Mounting dimensions

J	149 mm	Distance fixing bore
N	19 mm	Fixing bore
N ₁	149 mm	Distance fixing bore
n	4	Number of screwing holes

Additional information

	1	Number of housings
	F213	Housing
	UC213	Bearing designation