



RTUEY75-XL

Take-up housing unit

Schaeffler ID:
0009505210000

Take-up housing units RTUEY, cast iron housing, radial insert ball bearing with grub screws in inner ring, R seals

X-life

Technical information

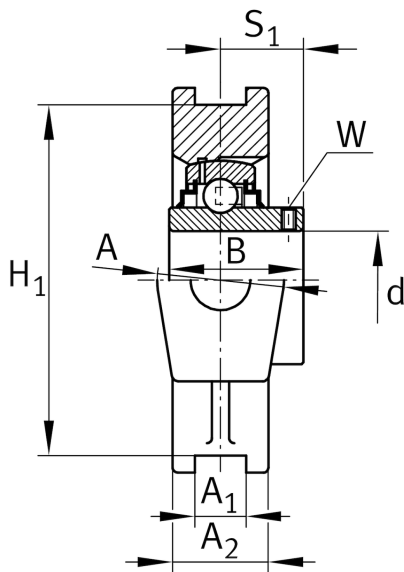
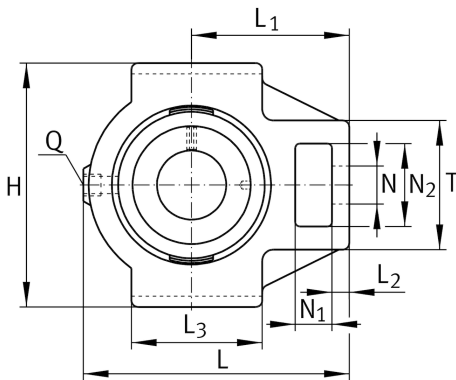

Dimensions

L_1	135 mm	Distance shaft axis
L_2	20 mm	Length fixed link
L_3	120 mm	Length guidance groove
A	70 mm	Width housing fixing side
N_1	35 mm	Width recess
N_2	70 mm	Height recess
B	77,8 mm	Width inner ring
S_1	44,5 mm	Distance of raceway to locking collar
T	110 mm	Height housing fixing side
Q	M6	Connection thread lubrication
A_2	50 mm	Width housing
	6,37 kg	Weight

Main Dimensions & Performance Data

d	75 mm	Bore diameter
H	166 mm	Height
L	214 mm	Length total

Mounting dimensions

A_1	25 mm	Width guidance groove
	H13	Width guidance groove clearance
H_1	151 mm	Distance guidance grooves
	0,25 mm	Upper distance guidance groove tolerance
	-0,25 mm	Lower distance guidance groove tolerance
N	41 mm	Fixing bore

Additional information

TUE15	Housing
GYE75-XL-KRR-B	Bearing designation