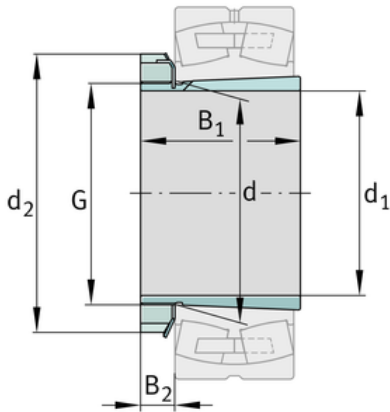
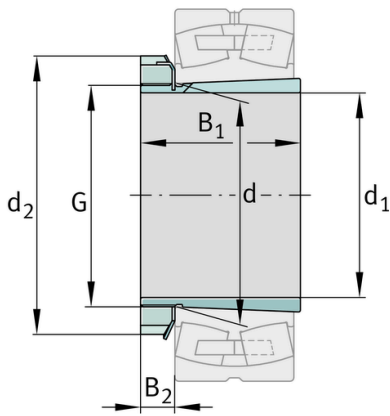
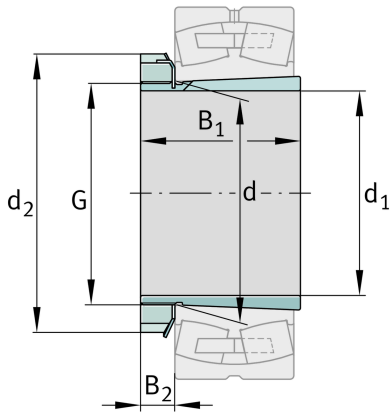
**FAG****H307****Adapter sleeve**Schaeffler ID:
0167310420000Adapter sleeve H, accessory rolling
bearing, complete, mechanical, FP

Technical information

**Dimensions**

d	35 mm	Bore diameter bearing
d ₂	52 mm	Outside diameter nut
B ₂	9,25 mm	Width nut and lock
	0,142 kg	Weight

Main Dimensions & Performance Data

d ₁	30 mm	bore diameter
G	M35x1,5	Thread
B ₁	35 mm	sleeve length

Additional information

	KM7	Locknut
	MB7	Fuse
	1:12	Taper

