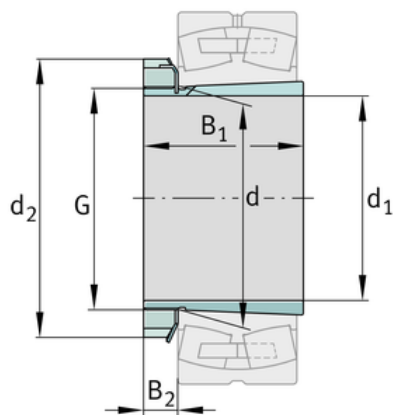
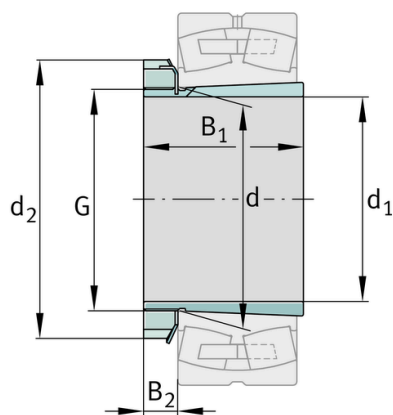
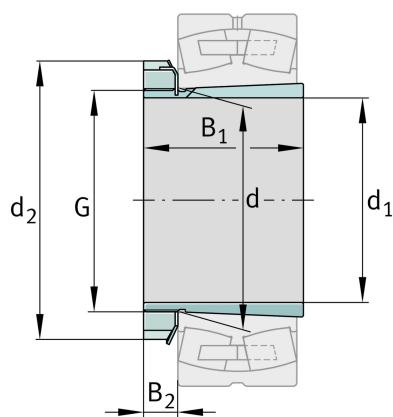
**FAG****H208**

Adapter sleeve

Schaeffler ID:
0167305690000Adapter sleeve H, accessory rolling
bearing, complete, mechanical, FP

Technical information

**Dimensions**

d	40 mm	Bore diameter bearing
d ₂	58 mm	Outside diameter nut
B ₂	10,25 mm	Width nut and lock
	0,182 kg	Weight

Main Dimensions & Performance Data

d ₁	35 mm	bore diameter
G	M40x1,5	Thread
B ₁	31 mm	sleeve length

Additional information

	KM8	Locknut
	MB8	Fuse
	1:12	Taper

