



Technical data

UCF210
Bearing units

Grey cast housing, radial insert ball bearing with socket set screws, seal with slinger

KIT CONTENT

UC210G2, F210

VISUAL (S)

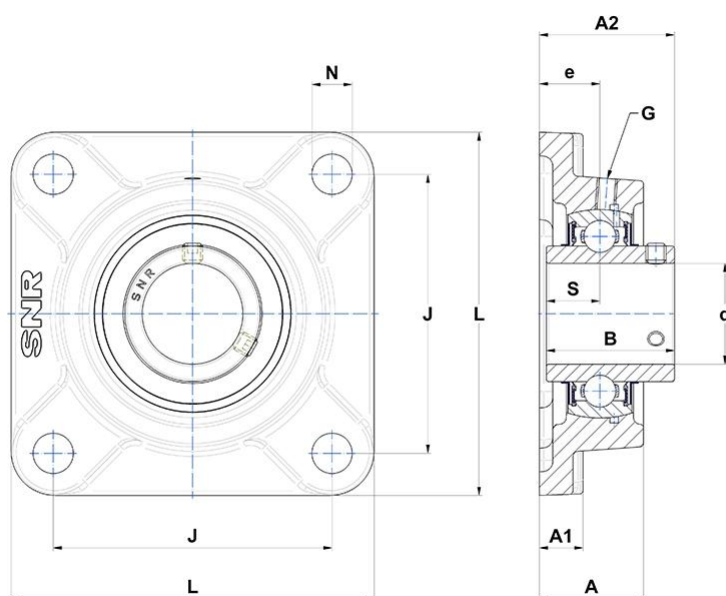

OTHER FEATURES

Mass	2,5 kg
Recommended tightening torque for set screw [Nm]	22.0 N-m

PRODUCT DIMENSIONS

Housing height (A)	40 mm
Housing foot height / flange height (A1)	16 mm
Total height (Housing + Insert) from mounting surface (A2)	54,6 mm

PRODUCT DIMENSIONS

Width of IR (B)	51,6 mm
Shaft dia (d)	50 mm
Distance mounting surface - bearing center (e)	22 mm
Grease fitting (G)	M6x1
Mounting hole distance (J)	111 mm
Housing width / dia (L)	143 mm
Mounting hole dimension (N)	16 mm
Dist. cent. of raceway to face IR on side opp. lock. device (S)	19 mm
Brand	SNR

PRODUCT PERFORMANCE

Dynamic load rating (C)	35,1 kN
Static load rating (C0)	23,2 kN
Operating temperature min.	-20 °C
Operating temperature max.	100 °C