

Technical data

K60X65X20

Needle roller and cage assemblies

VISUAL (S)

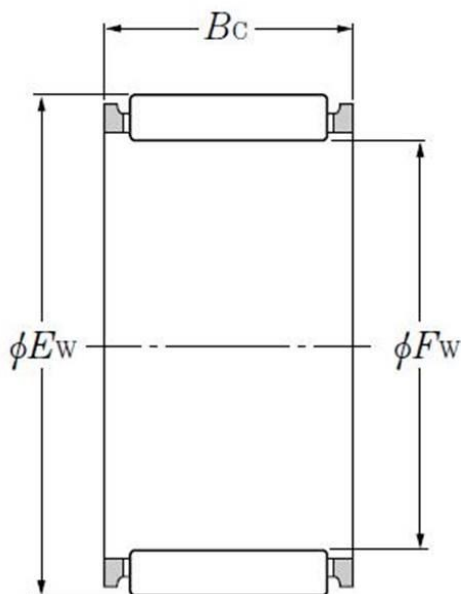

PRODUCT DIMENSIONS

Fw	60 mm
Ew	65 mm
Bc	20 mm
Mass	0,051 kg
Brand	NTN

PRODUCT PERFORMANCE

Cr	29,8 kN
C0r	71,5 kN
Nlim (grease)	4300 tr/min
Nlim (oil)	6500 tr/min
Min operating temperature, Tmin	-20 °C
Max operating temperature, Tmax	120 °C

K60X65X20

Needle roller and cage assemblies

PRODUCT PERFORMANCE

Characteristic cage frequency, FTF	0.48 Hz
Characteristic rolling element frequency, BSF	24.96 Hz
Characteristic outer ring frequency, BPF0	21.12 Hz
Characteristic inner ring frequency, BPII	22.88 Hz

ABUTMENT

b	20 mm
----------	-------