



FAG

6203-C

Deep groove ball bearing

Schaeffler ID:
0592577090000Deep groove ball bearing 62...-C, single
row, Generation C, steel sheet metal cage

Technical information

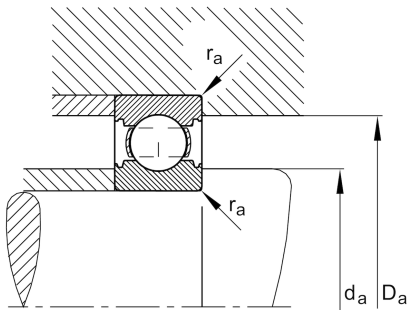
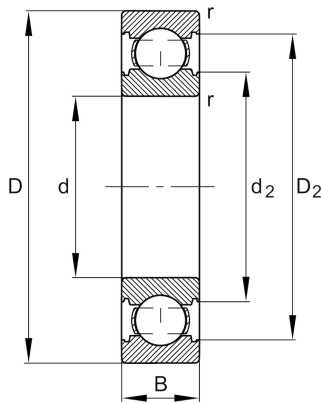
**Main Dimensions & Performance Data**

d	17 mm	Bore diameter
D	40 mm	Outside diameter
B	12 mm	Width
C_r	11.000 N	Basic dynamic load rating, radial
C_{0r}	4.750 N	Basic static load rating, radial
C_{ur}	330 N	Fatigue load limit, radial
n_G	29.000 1/min	Limiting speed
n_{gr}	20.100 1/min	Reference speed
	0,062 kg	Weight

Dimensions

r_{min}	0,6 mm	Minimum chamfer dimension
D_2	34,8 mm	Caliber diameter outer ring
d_2	22,8 mm	Caliber diameter inner ring

Mounting dimensions

$d_{a min}$	21,2 mm	Minimum diameter shaft shoulder
$D_{a max}$	35,8 mm	Maximum diameter of housing shoulder
$r_{a max}$	0,6 mm	Maximum fillet radius

Calculation factors

f_0	13	Calculation factor
-------	----	--------------------

Temperature range

T_{min}	-30 °C	Operating temperature min.
T_{max}	120 °C	Operating temperature max.