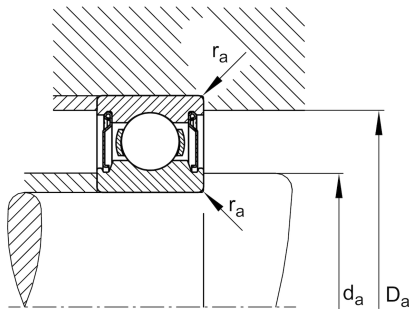
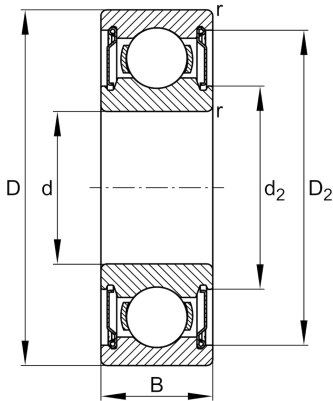
**FAG****6004-H-2Z**

Deep groove ball bearing

Schaeffler ID:
0938758860000

Deep groove ball bearing 60..-H-2Z, single row, H-Series, shields, steel sheet metal cage

Technical information

**Temperature range**

T_{min}	-20 °C	Operating temperature min.
T_{max}	120 °C	Operating temperature max.
	0,071 kg	Weight

Main Dimensions & Performance Data

d	20 mm	Bore diameter
D	42 mm	Outside diameter
B	12 mm	Width
C_r	9.380 N	Basic dynamic load rating, radial
C_{0r}	5.030 N	Basic static load rating, radial
C_{ur}	300 N	Fatigue load limit, radial
n_G	21.100 1/min	Limiting speed
n_{gr}	18.200 1/min	Reference speed

Dimensions

r_{min}	0,6 mm	Minimum chamfer dimension
D_2	37 mm	Caliber diameter outer ring
d_2	25,3 mm	Caliber diameter inner ring

Mounting dimensions

$d_{a min}$	23,2 mm	Minimum diameter shaft shoulder
$D_{a max}$	38,8 mm	Maximum diameter of housing shoulder
$r_{a max}$	0,6 mm	Maximum fillet radius

Calculation factors

f_0	13,9	Calculation factor
-------	------	--------------------