

Technical information

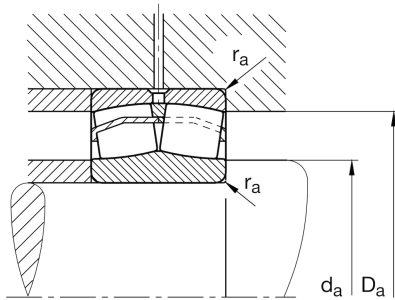
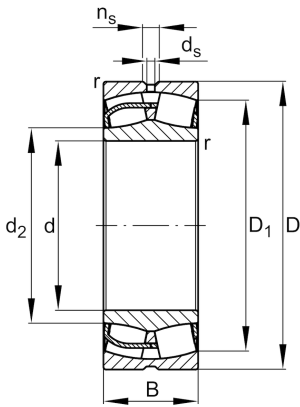

Main Dimensions & Performance Data

d	180 mm	Bore diameter
D	380 mm	Outside diameter
B	126 mm	Width
C_r	2.060.000 N	Basic dynamic load rating, radial
C_{0r}	2.460.000 N	Basic static load rating, radial
C_{ur}	195.000 N	Fatigue load limit, radial
n_G	2.030 1/min	Limiting speed
n_{gr}	1.230 1/min	Reference speed
	66,3 kg	Weight

Dimensions

r_{min}	4 mm	Minimum chamfer dimension
D_1	320,8 mm	Bore diameter outer ring
d_2	224,9 mm	Raceway diameter of the inner ring
d_s	12,5 mm	Diameter lubrication hole
n_s	23,5 mm	Width of lubricating groove

Mounting dimensions

$d_{a min}$	197 mm	Minimum diameter shaft shoulder
$D_{a max}$	363 mm	Maximum diameter of housing shoulder
$r_{a max}$	3 mm	Maximum recess radius

Temperature range

e	0,34	Limiting value of Fa/Fr for the applicability of diff. Values of factors X and Y
T _{min}	-30 °C	Operating temperature min.
Y ₁	1,96	Dynamic axial load factor
T _{max}	200 °C	Operating temperature max.
Y ₂	2,92	Dynamic axial load factor
Y ₀	1,92	Static axial load factor