

FAG

★ 22309-E1-XL

Spherical roller bearing

Schaeffler ID:
0167050680000Spherical roller bearings 223...E1, main
dimensions to DIN 635-2

★ Preferred product

X-life

Technical information

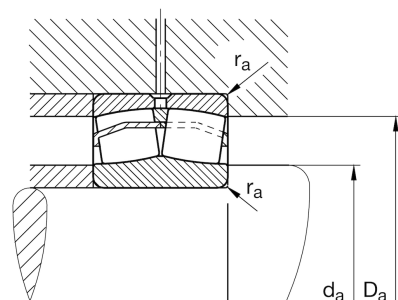
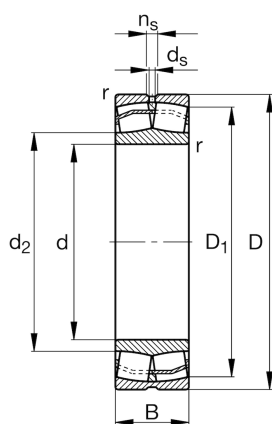

Main Dimensions & Performance Data

d	45 mm	Bore diameter
D	100 mm	Outside diameter
B	36 mm	Width
C_r	187.000 N	Basic dynamic load rating, radial
C_{0r}	183.000 N	Basic static load rating, radial
C_{ur}	16.500 N	Fatigue load limit, radial
n_G	6.800 1/min	Limiting speed
n_{gr}	5.000 1/min	Reference speed
	1,368 kg	Weight

Additional information

r_{min}	1,5 mm	Minimum chamfer dimension
D_1	84,7 mm	Bore diameter outer ring
d_2	58,9 mm	Raceway diameter of the inner ring
d_s	3,2 mm	Diameter lubrication hole
n_s	6,5 mm	Width of lubricating groove

Mounting dimensions

$d_{a min}$	54 mm	Minimum diameter shaft shoulder
$D_{a max}$	91 mm	Maximum diameter of housing shoulder
$r_{a max}$	1,5 mm	Maximum recess radius

Calculation factors

e	0,36	Limiting value of F_a/F_r for the applicability of diff. Values of factors X and Y
Y_1	1,9	Dynamic axial load factor
Y_2	2,83	Dynamic axial load factor
Y_0	1,86	Static axial load factor

Temperature range

T _{min}	-30 °C	Operating temperature min.
T _{max}	200 °C	Operating temperature max.