

FAG

22240-BE-XL-K

Spherical roller bearing

Schaeffler ID:
0663177110000

Spherical roller bearings 222..-E1-K, main dimensions to DIN 635-2, with tapered bore, taper 1:12

X-life

Technical information

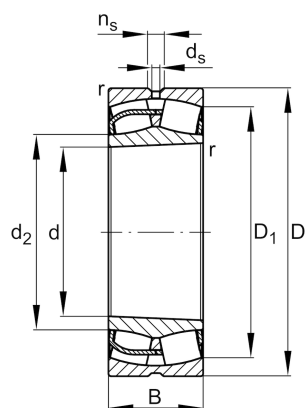

Main Dimensions & Performance Data

d	200 mm	Bore diameter
D	360 mm	Outside diameter
B	98 mm	Width
C_r	1.520.000 N	Basic dynamic load rating, radial
C_{0r}	1.990.000 N	Basic static load rating, radial
C_{ur}	180.000 N	Fatigue load limit, radial
n_G	2.330 1/min	Limiting speed
n_{gr}	1.510 1/min	Reference speed
	41,735 kg	Weight

Additional information

	H3140	Adapter sleeve
r_{min}	4 mm	Minimum chamfer dimension
D_1	310,9 mm	Bore diameter outer ring
	AH2240	Withdrawal sleeve
d_2	238,2 mm	Raceway diameter of the inner ring
d_s	9,5 mm	Diameter lubrication hole
n_s	17,7 mm	Width of lubricating groove

Mounting dimensions

$d_{a min}$	217 mm	Minimum diameter shaft shoulder
$d_{a max}$	234 mm	Maximum diameter of shaft shoulder
$D_{a max}$	343 mm	Maximum diameter of housing shoulder
$r_{a max}$	3 mm	Maximum recess radius
$d_{b min}$	212 mm	Minimum cavity diameter of the sleeve
$B_{a min}$	24 mm	Minimum cavity width of the sleeve

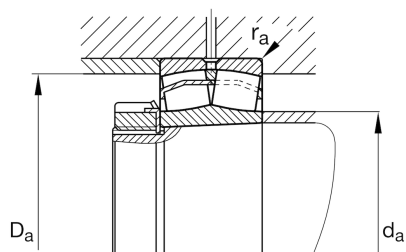

Calculation factors

e	0,26	Limiting value of Fa/Fr for the applicability of diff. Values of factors X and Y
Y ₁	2,57	Dynamic axial load factor
Y ₂	3,83	Dynamic axial load factor
Y ₀	2,52	Static axial load factor

Temperature range

T _{min}	-30 °C	Operating temperature min.
T _{max}	200 °C	Operating temperature max.