



FAG

★ 22217-E1-XL

Spherical roller bearing

Schaeffler ID:
0190004050000Spherical roller bearings 222...-E1, main
dimensions to DIN 635-2

★ Preferred product

X-life

Technical information

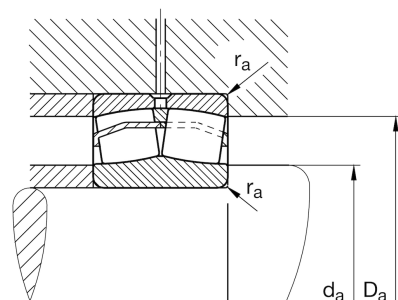
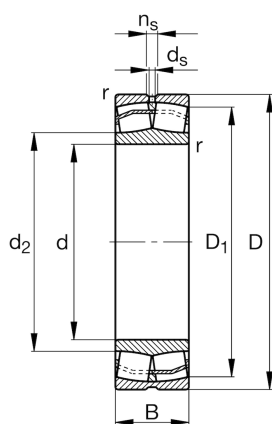

Main Dimensions & Performance Data

d	85 mm	Bore diameter
D	150 mm	Outside diameter
B	36 mm	Width
C_r	305.000 N	Basic dynamic load rating, radial
C_{0r}	325.000 N	Basic static load rating, radial
C_{ur}	39.000 N	Fatigue load limit, radial
n_G	5.700 1/min	Limiting speed
n_{gr}	3.450 1/min	Reference speed
	2,616 kg	Weight

Additional information

r_{min}	2 mm	Minimum chamfer dimension
D_1	135,4 mm	Bore diameter outer ring
d_2	99,7 mm	Raceway diameter of the inner ring
d_s	3,2 mm	Diameter lubrication hole
n_s	6,5 mm	Width of lubricating groove

Mounting dimensions

$d_{a min}$	96 mm	Minimum diameter shaft shoulder
$D_{a max}$	139 mm	Maximum diameter of housing shoulder
$r_{a max}$	2 mm	Maximum recess radius

Calculation factors

e	0,22	Limiting value of F_a/F_r for the applicability of diff. Values of factors X and Y
Y_1	3,04	Dynamic axial load factor
Y_2	4,53	Dynamic axial load factor
Y_0	2,97	Static axial load factor

Temperature range

T _{min}	-30 °C	Operating temperature min.
T _{max}	200 °C	Operating temperature max.