



FAG

★ 22211-E1-XL

Spherical roller bearing

Schaeffler ID:
0167036180000Spherical roller bearings 222...-E1, main
dimensions to DIN 635-2

★ Preferred product

X-life

Technical information

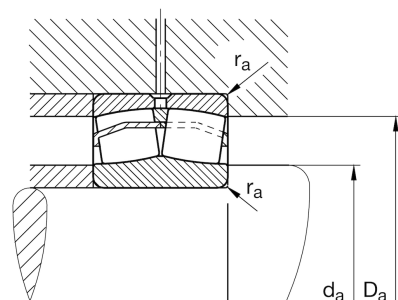
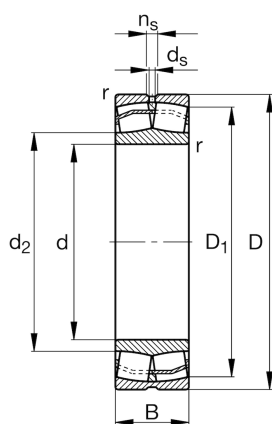

Main Dimensions & Performance Data

d	55 mm	Bore diameter
D	100 mm	Outside diameter
B	25 mm	Width
C_r	129.000 N	Basic dynamic load rating, radial
C_{0r}	130.000 N	Basic static load rating, radial
C_{ur}	17.700 N	Fatigue load limit, radial
n_G	9.000 1/min	Limiting speed
n_{gr}	4.650 1/min	Reference speed
	0,519 kg	Weight

Additional information

r_{min}	1,5 mm	Minimum chamfer dimension
D_1	89,8 mm	Bore diameter outer ring
d_2	67,6 mm	Raceway diameter of the inner ring
d_s	3,2 mm	Diameter lubrication hole
n_s	4,8 mm	Width of lubricating groove

Mounting dimensions

$d_{a min}$	64 mm	Minimum diameter shaft shoulder
$D_{a max}$	91 mm	Maximum diameter of housing shoulder
$r_{a max}$	1,5 mm	Maximum recess radius

Calculation factors

e	0,21	Limiting value of F_a/F_r for the applicability of diff. Values of factors X and Y
Y_1	3,17	Dynamic axial load factor
Y_2	4,72	Dynamic axial load factor
Y_0	3,1	Static axial load factor

Temperature range

T _{min}	-30 °C	Operating temperature min.
T _{max}	200 °C	Operating temperature max.