



FAG

32213-H

Tapered roller bearing

Schaeffler ID:
0953901460000Tapered roller bearings 322, main
dimensions to DIN ISO 355 / DIN 720,
separable, adjusted or in pairs

Technical information

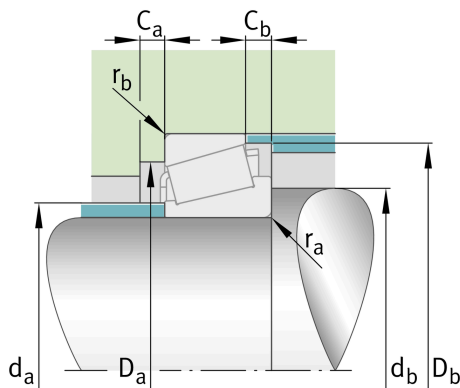
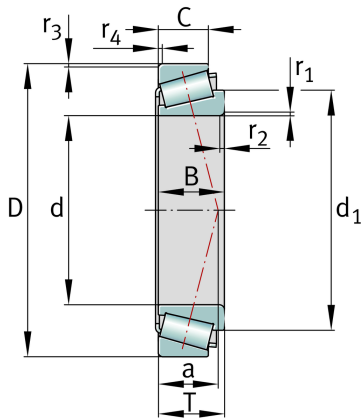
**Main Dimensions & Performance Data**

d	65 mm	Bore diameter
D	120 mm	Outside diameter
B	31 mm	Width, inner ring
C	27 mm	Width, outer ring
T	32,75 mm	Width, total
C_r	148.000 N	Basic dynamic load rating, radial
C_{0r}	200.000 N	Basic static load rating, radial
C_{ur}	25.000 N	Fatigue load limit, radial
n_G	4.720 1/min	Limiting speed
n_{gr}	3.600 1/min	Thermal speed rating
$\approx m$	1,56 kg	Weight

Mounting dimensions

$d_{a \max}$	76 mm	Maximum diameter of shaft shoulder
$d_{b \min}$	74 mm	Minimum diameter of shaft shoulder
$D_{a \min}$	104 mm	Minimum diameter of housing shoulder
$D_{a \max}$	111 mm	Maximum diameter of housing shoulder
$D_{b \min}$	115 mm	Minimum diameter of housing shoulder
$C_{a \min}$	4 mm	Minimum axial space
$C_{b \min}$	5,5 mm	Minimum axial space
$r_{a \max}$	2 mm	Maximum fillet radius of shaft
$r_{b \max}$	1,5 mm	Maximum fillet radius of housing

Dimensions

$r_{1,2 \text{ min}}$	2 mm	Minimum chamfer dimension of inner ring back face
$r_{3,4 \text{ min}}$	1,5 mm	Minimum chamfer dimension of outer ring back face
a	27 mm	Distance between the apexes of the pressure cones
d_1	93,3 mm	Guidance rib diameter of inner ring

Temperature range

T_{min}	-30 °C	Operating temperature min.
T_{max}	120 °C	Operating temperature max.

Calculation factors

e	0,4	Limiting value of F_a/F_r for the applicability of diff. Values of factors X and Y
Y	1,48	Dynamic axial load factor
Y_0	0,81	Static axial load factor

Additional information

	T3EC065	Comparative designation to ISO 10317 and ISO 355
--	---------	--