

# DATASHEET

## Variable Speed Drives



### Main Features

Reference : CFW300B06P5T4NB20  
 Product code : 14146887  
 Product line : CFW300

### Basic data

Power supply : 380-480 V  
 Input minimum-maximum voltage : 323-528 V  
 Input phases : Three-phase  
 - In : 3  
 - Out : 3

	Range 1	Range 2
	380-415 V	440-480 V
Overload regime	Heavy (HD)	Heavy (HD)
Rated current (HD)	6.5 A	5.6 A
Overload current for 60 s (HD)	9,8 A	8,4 A
Single-phase input current (HD) [1]	Not applicable	Not applicable
Three-phase / DC input current (HD) [1]	7,8 A	6,7 A

Maximum applicable motor:

Voltage/Frequency	Normal Overload (ND)	Heavy Overload (HD)
380V / 50Hz	Not applicable	4 / 3
380V / 60Hz	Not applicable	4 / 3
400V / 50Hz	Not applicable	4 / 3
400V / 60Hz	Not applicable	4 / 3
440V / 50Hz	Not applicable	4 / 3
440V / 60Hz	Not applicable	4 / 3
460V / 60Hz	Not applicable	4 / 3
480V / 60Hz	Not applicable	4 / 3

Dynamic braking [3] : Standard without braking  
 External RFI filter : CFW300-KFB-T4  
 Link Inductor : No  
 Memory card : Not included in the product  
 USB port : Yes, by CFW300-CUSB  
 Line frequency : 50/60Hz  
 Line frequency range (minimum - maximum) : 48-62 Hz  
 Phase unbalance : Less or equal to 3% of input rated line voltage  
 Transient voltage and overvoltage : Category III  
 Typical input power factor : 0,83  
 Displacement factor : 0,98  
 Rated efficiency :  $\geq 97\%$   
 Maximum connections (power up cycles - on/off) per hour : 10 (1 each 6 minutes)  
 DC power supply : Allow  
 Switching frequency [4]: : 5 kHz  
 Selectable switching frequency : 2,5 and 15 kHz  
 Real-time clock : Not available  
 Copy Function : Yes, by CFW100-CFW300-MMF  
 Dissipated power [5]: : 91 W

### Source available to the user

Output voltage : 10 Vdc  
 Maximum capacity : 50 mA

### Control/performance data

Power supply : Switched-mode power supply  
 Control method - induction motor : V/f (escalar) and VVW  
 Encoder interface : Available with CFW300-IOAENC  
 Control output frequency [5] : 0-400 Hz  
 Frequency resolution : 0.1 Hz

### V/F Control

- Speed regulation : 1% of rated speed  
 - Speed variation : 1:20  
 VVW Control  
 - Speed regulation : 1% of rated speed  
 - Speed variation : 1:30  
 Sensorless vector control  
 - Speed regulation : Not applicable

# DATASHEET

## Variable Speed Drives



### V/F Control

- Speed variation : Not applicable
- Vector control with Encoder
- Speed regulation : Not applicable

### Analog Inputs

- Quantity (standard) : 1
- Levels : 0-10V, 0-20mA and 4-20mA
- Impedance for voltage input : 100 kΩ
- Impedance for current input : 500 Ω
- Function : Programmable
- Maximum allowed voltage : 30 Vcc

### Digital inputs

- Quantity (standard) : 4
- Activation : Active low and high
- Maximum low level : 5 V (low) and 10 V (high)
- Minimum high level : 10 V (low) and 20 V (high)
- Input current : 11 mA
- Maximum input current : 20 mA
- Function : Programmable
- Maximum allowed voltage : 30 Vcc

### Analog outputs

- Quantity (standard) : Only with plug-in
- Levels : Not applicable
- RL for voltage output : Not applicable
- RL for current output : Not applicable
- Function : Not applicable

### Digital outputs

- Quantity (standard) : 1 NO/NC relay
- Maximum voltage : 250 Vac
- Maximum current : 0.5 A
- Function : Programmable

### Communication

- Modbus-RTU (with accessory: CFW300-CRS485, CFW300-CRS232, CFW300-CUSB or CFW300-CBLT)
- Modbus/TCP (with accessory: CFW300-CETH)
- Profibus DP (with accessory: CFW300-CPDP)
- Profibus DPV1 (Not available)
- Profinet (Not available)
- CANopen (with accessory: CFW300-CCAN)
- DeviceNet (with accessory: CFW300-CCAN)
- EtherNet/IP (with accessory: CFW300-CETH)
- EtherCAT (Not available)
- Bluetooth (with accessory: CFW300-CBLT)
- BACnet (with accessory: CFW300-CRS485)

### Available protection

- Output phase-phase overcurrent/Short
- Not applicable
- Under/Overvoltage in power
- Heat sink overtemperature
- Motor overload
- Not applicable
- Fault/External alarm
- Programming error
- CPU or memory failure

### Operation interface (HMI)

- Availability : Included in the product
- HMI installation : Fixed HMI
- Number of HMI buttons : 4
- Display : Numeric LCD
- Indication accuracy : 10% of rated current
- Speed resolution : 0,1 Hz
- Standard HMI degree of protection : IP20
- HMI battery type : Not applicable
- HMI battery life expectancy : Not applicable
- Remote HMI type : Accessory CFW300-KHMIR
- Remote HMI frame : Not applicable
- Remote HMI degree of protection : IP54

### Ambient conditions

- Enclosure : IP20

# DATASHEET

## Variable Speed Drives



### Ambient conditions

Degree of pollution (EN50178 and UL508C) : 2  
 Temperature around the inverter: of 0 °C / 32 °F to 40 °C / 104 °F. For temperatures above the specified is necessary to apply current reduction of 2 % per °C of 40 (104) to 50 °C (122 °F).  
 Relative humidity: 5% to 95% without condensation.

### Sustainability policies

RoHS : Yes  
 Conformal Coating : 3C2 (IEC 60721-3-3:2002)

### Dimensions and weight

- Size : B  
 - Height : 198.9 mm / 7.8 in  
 - Width : 70 mm / 2.76 in  
 - Depth : 158.4 mm / 6.2 in  
 - Weight : 1,2 kg / 2.6 lb

### Mechanical Installation

Mounting position : Surface or DIN rail  
 Fixing screw : M4  
 Tightening torque : 2 N.m / 1.48 lb.ft  
 Allows side-by-side assembly : Yes, without derating  
 Minimum spacing around the inverter:  
 - Top : 35 mm / 1.38 in  
 - Bottom : 50 mm / 1.97 in  
 - Front : 40 mm / 1.57 in  
 - Between inverters (IP20) : Not applicable

### Electrical connections

Cable gauges and tightening torques:

	Recommended cable gauge	Recommended tightening torque
Power	1,5 mm <sup>2</sup> (16 AWG)	0,8 N.m / 0.6 lb.ft
Braking	Not applicable	0,8 N.m / 0.6 lb.ft
Grounding	2,5 mm <sup>2</sup> (14 AWG)	0.8 N.m / 0.6 lb.ft
Control	0,5 to 1,5 mm <sup>2</sup> (20 to 14 AWG)	0.4 N.m / 0.30 lb.ft

### Additional especifications

SoftPLC : Yes, incorporated  
 Maximum breaking current : Not available  
 Minimum resistance for the brake resistor : Not available  
 Recommended fuse : FNH000-20K-A  
 Recommended circuit breaker [6] : MPW40-3-U010

### Standards

Safety	<ul style="list-style-type: none"> <li>- Not applicable</li> <li>- UL 840 - Insulation coordination including clearances and creepage distances for electrical equipment.</li> <li>- EN 61800-5-1 - Safety requirements electrical, thermal and energy.</li> <li>- EN 50178 - Electronic equipment for use in power installations.</li> <li>- EN 60204-1-Safety of machinery. Electrical equipment of machines. Part 1: General requirements. Note: To have a machine in accordance with that standard, the manufacturer of the machine is responsible for the installation of an emergency-stop device and a network switching equipment.</li> <li>- EN 60146 (IEC 146) - Semiconductor converters.</li> <li>- EN 61800-2 - Adjustable speed electrical power drive systems - Part 2: General requirements - Rating specifications for low voltage adjustable frequency AC power drive systems.</li> </ul>
Electromagnetic Compatibility	<ul style="list-style-type: none"> <li>- EN 61800-3 - Adjustable speed electrical power drive systems - Part 3: EMC product standard including specific test methods.</li> <li>- EN 55011 - Limits and methods of measurement of radio disturbance characteristics of industrial, scientific and medical (ISM) radio-frequency equipment.</li> <li>- CISPR 11 - Industrial, scientific and medical (ISM) radio-frequency equipment - Electromagnetic disturbance characteristics - Limits and methods of measurement.</li> <li>- EN 61000-4-2 - Electromagnetic compatibility (EMC) - Part 4: Testing and measurement techniques - Section 2: Electrostatic discharge immunity test.</li> <li>- EN 61000-4-3 - Electromagnetic compatibility (EMC) - Part 4: Testing and measurement techniques - Section 3: Radiated, radio-frequency, electromagnetic field immunity test.</li> <li>- EN 61000-4-4 - Electromagnetic compatibility (EMC) - Part 4: Testing and measurement techniques - Section 4: Electrical fast transient/burst immunity test.</li> <li>- EN 61000-4-5 - Electromagnetic compatibility (EMC) - Part 4: Testing and measurement techniques - Section 5: Surge immunity test.</li> </ul>

# DATASHEET

## Variable Speed Drives



### Standards

	<ul style="list-style-type: none"><li>- EN 61000-4-6 - Electromagnetic compatibility (EMC)- Part 4: Testing and measurement techniques - Section 6: Immunity to conducted disturbances, induced by radio-frequency fields.</li><li>- With external filter only</li></ul>
Mechanical Construction	<ul style="list-style-type: none"><li>- EN 60529 - degrees of protection provided by enclosures (IP code).</li><li>- UL 50 - enclosures for electrical equipment.</li><li>- IEC 60721-3-3 - classification of environmental conditions - part 3: classification of groups of environmental parameters and their severities - section 3: stationary use at weather protected locations level 3m4.</li><li>- EN 60529 e UL 50</li></ul>

### Certifications

- 1) Considering minimum impedance of 1%;
- 2) Motor power is orientative, valid for standard WEG Motors of IV poles. The correct sizing must be done according to the nominal current of the motor used, which must be less than or equal to the rated output current of the inverter;
- 3) Braking resistor is not included;
- 4) For operation with a switching frequency above nominal, apply derating to the output current (refer to the user manual).
- 5) Surface mounting, HD overload.
- 6) Only for electrical circuit protection. For protection of inverters, use aR fuses indicated.
- 7) Only with external filter.

1

2

3

4

5

6

A

B

C

D

E

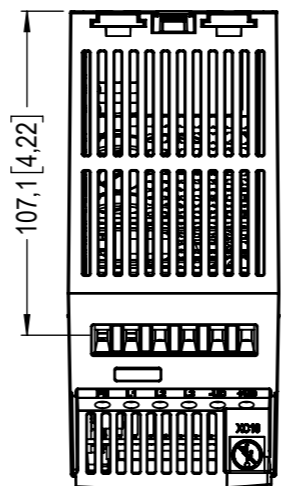
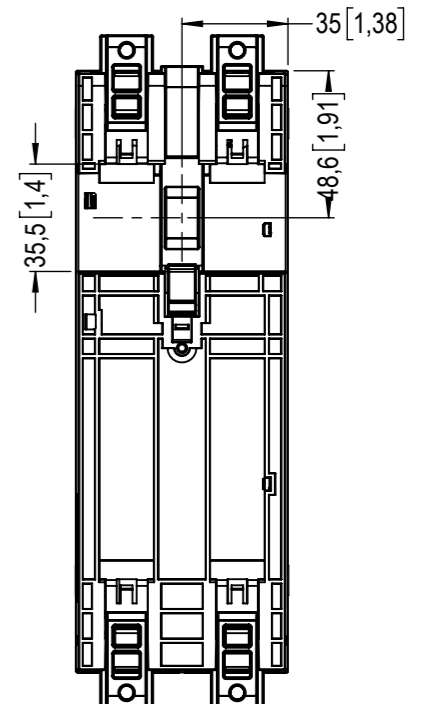
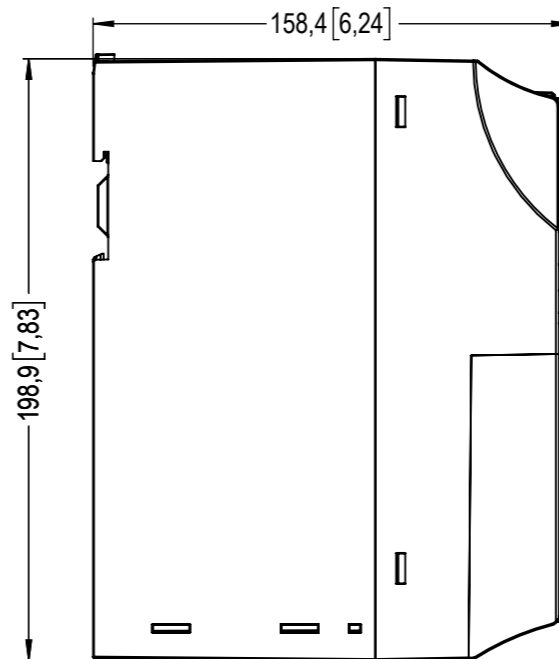
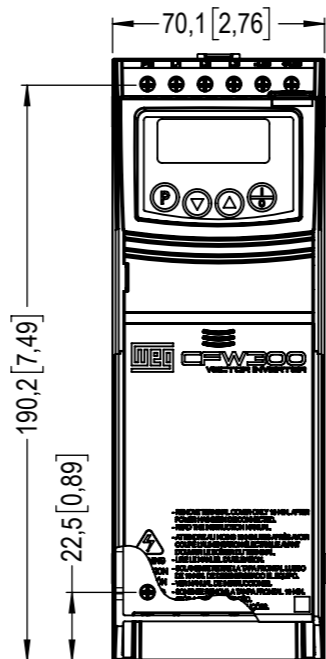
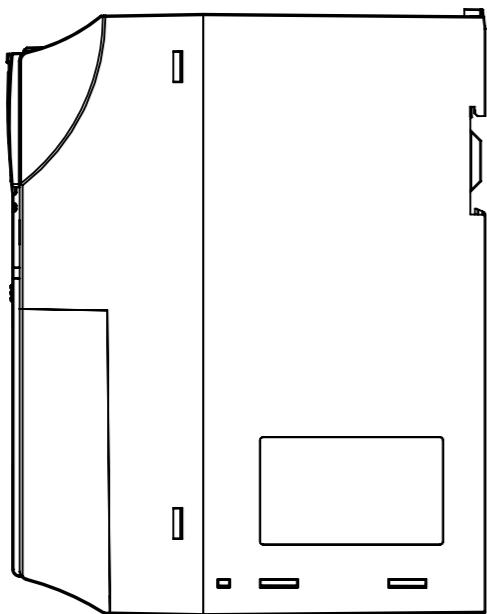
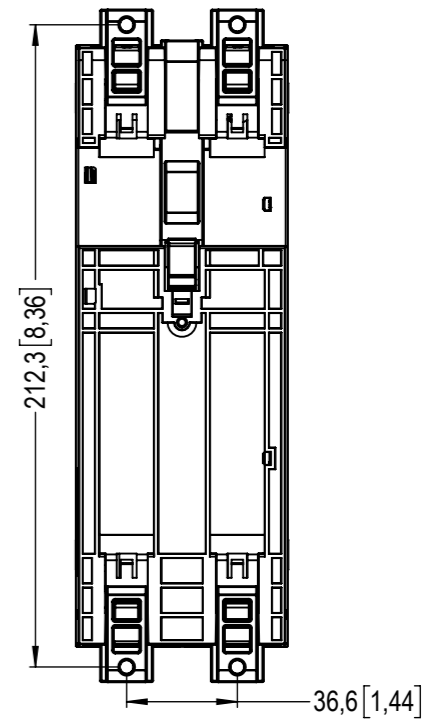
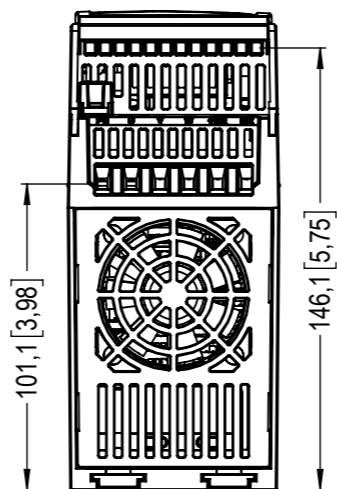
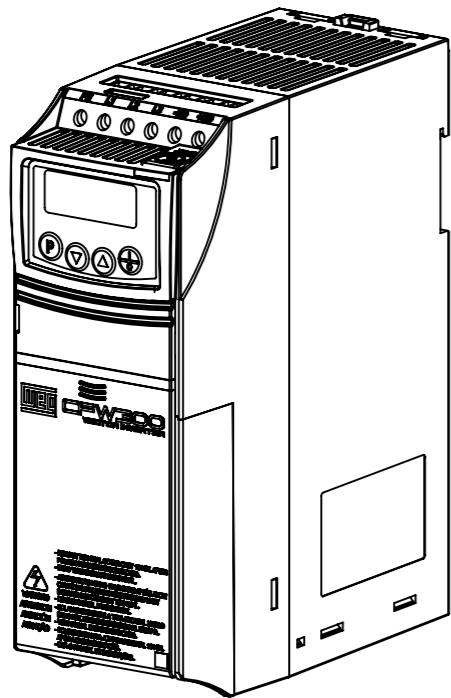

MASSA BRUTA/GROSS WEIGHT		kg	MASSA LÍQUIDA/NET WEIGHT		kg	ESCALA/SCALE		
ECM	LOC	RESUMO DE MODIFICAÇÕES SUMMARY OF MODIFICATIONS			EXECUTADO EXECUTED	VERIFICADO CHECKED	LIBERADO RELEASED	DATA DATE
EXEC		CFW300 400v			10005683096			
VERIF/CHECKED		SIZE B						
LIBER/RELEASED								
DT LIBER/REL DT					FOL/SHEET 1 / 1			

