

TIMKEN

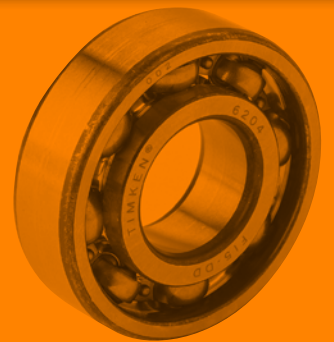

TIMKEN® DEEP GROOVE BALL BEARING CATALOG



DEEP GROOVE BALL BEARING CATALOG INDEX

TIMKEN OVERVIEW.....	2
PRODUCTS AND SERVICES.....	5
HOW TO USE THIS CATALOG.....	9
SHELF LIFE AND STORAGE.....	10
WARNINGS.....	12
ENGINEERING.....	13
Bearing Size Range.....	14
Deep Groove Ball Bearing Types.....	14
Deep Groove Ball Bearing Configurations.....	14
Ball Bearing Cages.....	15
Shields and Seals.....	16
Lubrication.....	17
Bearing Life.....	18
Rating Life.....	18
Speed Rating.....	18
Radial Internal Clearance.....	19
Deep Groove Ball Bearing Tolerances.....	20
Fitting Practice.....	21
DEEP GROOVE BALL BEARINGS.....	27
Nomenclature.....	28
Standard 6000 Series.....	29
61000 Thin-Section Series.....	31
16000 Narrow Series.....	32
62000-63000 Wide Series.....	33
Extra-Small 600 Series.....	34



GROW STRONGER WITH TIMKEN

Every day, people around the world count on the strength of Timken. Our expertise in metallurgy, friction management and mechanical power transmission helps them accelerate improvements in productivity and uptime.

We supply products and services that can help keep your operations moving forward, whether you need drive train kits for commercial vehicles, durable housings for bearings in dirty environments, couplings that avoid metal-to-metal contact between motors and gearboxes, repair services for bearings and gearboxes, roller chain for dry, abrasive and high-moisture applications, or other products or services for your applications.

When you choose Timken, you receive more than high-quality products and services: you gain a worldwide team of highly trained and experienced Timken people committed to working collaboratively with you to improve your business.

Globally, our 14,000 people provide reliable answers for a wide range of operations in manufacturing, mining, medical equipment, aerospace, transportation, oil and gas – and other diverse industries.



INCREASE YOUR EQUIPMENT UPTIME

In addition to high-quality bearings and mechanical power transmission components, we provide valuable integrated products and services. For example, we offer repair services and monitoring equipment that can alert you to problems before they impact your uptime.

Additionally, we offer a broad selection of seals, premium lubricants, lubricators, couplings and chain to keep your operations moving smoothly.

Our technology centers in the United States, Europe and Asia help pioneer tomorrow's innovations with extensive basic and applied scientific research programs. Through internal development and strategic acquisition of innovative companies, we continue to expand our portfolio of highly engineered bearings and components.



INDUSTRIAL INNOVATOR

Today, manufacturing and processing equipment handles heavier loads, faster speeds and greater expectations than ever before. As finished-product quality requirements increase, producers continue to place a premium on equipment uptime and performance.

Timken has more than a century of experience developing bearings and related solutions that help equipment run more efficiently in a wide range of applications. As the leader in friction-management and power-transmission solutions for industrial markets, Timken helps operators improve their equipment's performance and uptime. We accomplish this by providing custom solutions – from bearings that stand up to the harshest environments to condition monitoring that minimizes maintenance costs and improves plant productivity.

INNOVATION AND CUSTOMER SUPPORT

Timken operates technology centers around the world dedicated to developing innovative concepts and products that help you operate more efficiently. Our technical leadership and customer support reaches far beyond our products. Timken customers have access to sales and service engineering support at their plants, and options for additional support from application engineers who specialize in a variety of industrial applications.

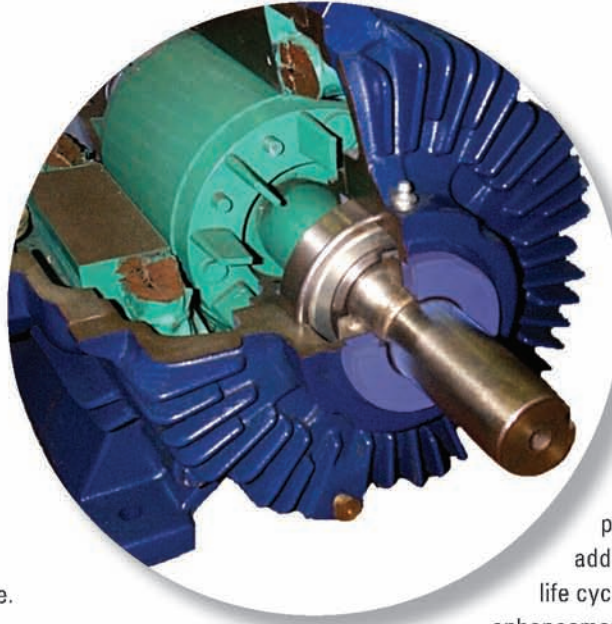

CORE CAPABILITIES

Timken has evolved from its early roots as a bearing producer to a supplier offering much more, including friction-management and power-transmission solutions that add value throughout the complete life cycle of a system. Our material

enhancements improve bearing life and can help protect against debris and corrosion – two

challenges encountered frequently in various industrial applications. Our precision manufacturing capabilities and commitment to quality ensure global consistency in design and manufacturing at every Timken facility. A global distribution network provides our customers with easy access to Timken products and services throughout the world.

We leverage these core capabilities as we work with original equipment manufacturers (OEM) and designers to integrate our technologies into equipment so that end users can enjoy the performance benefits of Timken products from the first day of operation. OEMs depend on Timken for our engineering expertise, manufacturing capabilities and emphasis on reliable performance.

PRODUCTS AND SERVICES

We offer equipment builders and operators one of the most extensive friction-management product and service portfolios in the industry.

We also strictly adhere to the Timken Quality Management System in every plant worldwide, so each bearing product meets the same high-quality standards – no matter where in the world it is manufactured.

BEARINGS

Timken provides a broad range of bearing designs and configurations for use in mobile, industrial and auxiliary equipment.

Bearing types include:

- Tapered roller bearings** – Tapered roller bearings are uniquely designed to manage both thrust and radial loads, and are available in single- and multi-row designs with a wide range of assembly options. Our extensive offering of tapered roller bearing combinations offers equipment builders and operators simple, reliable and less costly design solutions.
- Cylindrical roller bearings** – This design generally offers the highest possible radial load capacity for a given size compared to other roller bearing types. Single-row and double-row cylindrical roller bearings are ideal for many mill stand, gear drive and other auxiliary equipment applications, while four-row cylindrical roller bearings are used in roll neck applications. Timken offers both single and multi-row cylindrical roller bearings. Custom designs are available upon request for specific applications.
- Spherical roller bearings** – Spherical roller bearings offer high radial and moderate thrust capacity together with maximum static and dynamic misalignment capability. Timken® spherical roller bearings provide high-static load capacity and advanced geometry that reduces friction

and heat generation. These bearings are available in a range of dimensional stability configurations to suit elevated operating temperatures.

- Thrust bearings** – Thrust bearings are available in ball, cylindrical, spherical and tapered designs. Thrust bearings are ideal for applications experiencing heavy axial loads, and they are used extensively in heavy industrial processing equipment.



- **Ball bearings** – Ball bearings are used extensively in auxiliary applications that have light loads and/or high-speed conditions. Timken offers a range of radial, thrust and angular contact ball bearings in both metric and inch sizes. Please contact your Timken sales engineer for detailed information on these product ranges.

HOUSED UNITS

Maintaining critical uptime can require more durable, heavy-duty components capable of protecting spherical, tapered and ball bearings in debris-filled, contaminated or high-moisture environments. Timken has engineered a lineup of housed units – one of the broadest available – to meet these various demands and offer the ideal level of bearing protection.

SNT/SAF PLUMMER (PILLOW) BLOCK HOUSED UNITS

Customizable design, interchangeable components and reliable spherical roller bearings deliver the heavy-duty performance that helps protect equipment and improve uptime in the harshest environments.

- Variety of sealing options keep grease in and contamination out
- Easily convert from fixed to float configurations in the field
- Easy-to-remove cap for inspections, replacement and maintenance

SPHERICAL ROLLER BEARING SOLID BLOCK HOUSED UNITS

Cast steel housings with high-performance spherical roller bearings deliver outstanding durability in extreme conditions, including severe shock loads and vibration.

- Multiple sealing options provide protection from contaminants in the harshest environments
- Can be mounted and aligned in 15 minutes with a variety of available shaft-locking mechanisms
- Easily convert from fixed to float configurations in the field

TYPE E TAPERED ROLLER BEARING HOUSED UNITS

A new standard in performance, Type E tapered roller bearing housed units are ideal for fixed positions and can withstand the most demanding conditions with less downtime and maintenance.

- Seal provides industry-leading protection against contamination
- Optimized internal geometries offer the highest dynamic load ratings in the industry for improved bearing life and performance

BALL BEARING HOUSED UNITS

Timken has delivered innovations that offer advanced performance, including wide inner ring bearing and ball bearing housed units. Easy installation, multi-seal design and multiple housing styles help ball bearing housed units support a wide range of demanding applications and conditions.



- Provide advanced protection against contaminants in a robust, compact unit
- Withstand static misalignment of +/- 3 degrees
- Effective grease retention, and reduced debris and moisture ingress improve performance

REVOLVO SPLIT CYLINDRICAL ROLLER BEARING HOUSED UNIT

Reduce installation time in tight spaces and trapped applications. Revolvo's line of split-to-the-shaft cylindrical roller bearing housed units enables the bearing to be installed without requiring access to the shaft ends.

HIGH-PERFORMANCE BEARING SOLUTIONS

Timken provides a variety of high-performance bearing solutions, including Timken® AquaSpexx®, DuraSpexx® and thin dense chrome bearings for corrosion protection. Our debris-resistant bearings are ideal for contaminated and/or marginal lubrication conditions.

We also provide customized bearing solutions such as special race profiles to meet special application requirements.

In addition to component geometry and metallurgy, we find many ways to enhance bearing performance by applying unique surface finishes and special coatings on rollers, raceways and other functional surfaces.



Engineered surfaces and topographical modifications reduce surface roughness to lower levels rather than what can be achieved through conventional grinding and honing methods. We also offer proprietary coatings that can create a surface up to four times harder than steel with twice the elasticity. For more information on Timken high-performance bearings and engineered surfaces, contact a Timken sales representative.

POWER TRANSMISSION COMPONENTS AND SYSTEMS

Timken offers an expanding range of power transmission components including seals, couplings and engineered chain.

Timken develops seals using advanced material and process solutions that help protect machinery and minimize plant downtime. We offer a comprehensive line of large-bore oil and grease seals, and metallic and non-metallic bearing isolators.

Timken® Quick-Flex® couplings are highly durable and need minimal maintenance. They are easy to install and require no lubrication. The couplings are designed to connect motors and gearboxes with other moving equipment with capacity to transmit the same or more torque than a gear coupling in the same dimensions. The Quick-Flex coupling's innovative design utilizes an advanced elastomeric element to transmit the torque and eliminates any interference between coupling hubs that can damage equipment.

Timken manufactures precision roller chains that meet demanding steel industry applications. We build chains to precise specifications for strength and maximum wear life. The offering includes a complete line of roller chains, attachment chains and engineered conveyor chains.

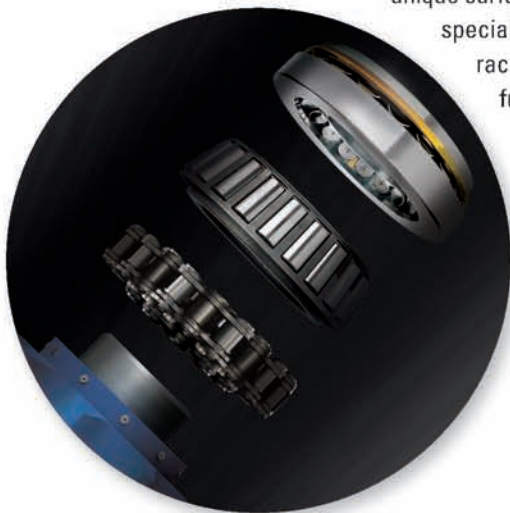



LUBRICANTS AND LUBRICATION SYSTEMS

Serving industries around the world, Timken lubricants and lubrication systems are essential in maximizing performance, productivity and uptime.

Leveraging our expertise in tribology and anti-friction bearings, we've developed lubricants – including 27 formulations of grease – that help ensure smooth operation. Our single- and multi-point lubricators, in addition to Interlube automated lubrication delivery systems, dispense precise amounts of grease, saving time and money over manual application.

- High-temperature, anti-wear and water-resistant additives optimize consistent operation in even the most challenging environments.
- Multifaceted delivery systems serve virtually any application – from simple, single-point needs to multi-point or progressive systems where an automated process can maximize uptime and reduce maintenance costs.
- Patented chain lubrication systems inject oil where it's needed for reduced wear.

MAINTENANCE TOOLS

Timken maintenance tools may extend bearing life by facilitating proper installation, removal and service. They also help simplify maintenance practices. We provide induction heaters, impact fitting tools, and hydraulic and mechanical pullers.

SERVICES

Used bearings and related components often can be returned to their original specifications with less time and cost than purchasing new. We offer complete remanufacture and reconditioning services for many components including bearings, chocks, housings, rolls and more.

Our gearbox repair service providers are globally recognized as experts in power transmission solutions for heavy industrial markets, repairing nearly all large gearbox makes or models, with onsite emergency breakdown service available if needed.

Timken offers a full range of maintenance and reconditioning services through our remanufacturing and repair operations. Using these services can lead to improved plant efficiency and reduced overall production costs.

TRAINING

We offer industry-specific training programs designed for plant professionals, as well as onsite customized training to meet your specific needs. Our training programs are available at select locations around the world and cover every phase of bearing performance. Class time is balanced with extensive hands-on training and tours of Timken facilities.



HOW TO USE THIS CATALOG

We designed this catalog to help you find the Timken bearings best suited to your specifications.

Timken offers an extensive range of bearings and accessories in both metric and imperial sizes. Contact your Timken sales engineer to learn more about our complete line for the special needs of your application.

This publication contains dimensions, tolerances and load ratings, as well as engineering sections describing fitting practices for shafts and housings, internal clearances, materials and other bearing features. It provides valuable assistance in the initial consideration of the type and characteristics of the bearings that may best suit your particular needs.

ISO and ANSI/ABMA, as used in this publication, refer to the International Organization for Standardization and the American National Standards Institute/American Bearing Manufacturers Association.

Updates are made periodically to this catalog. Visit www.timken.com for the most recent version of the Timken® Deep Groove Ball Bearing Catalog.

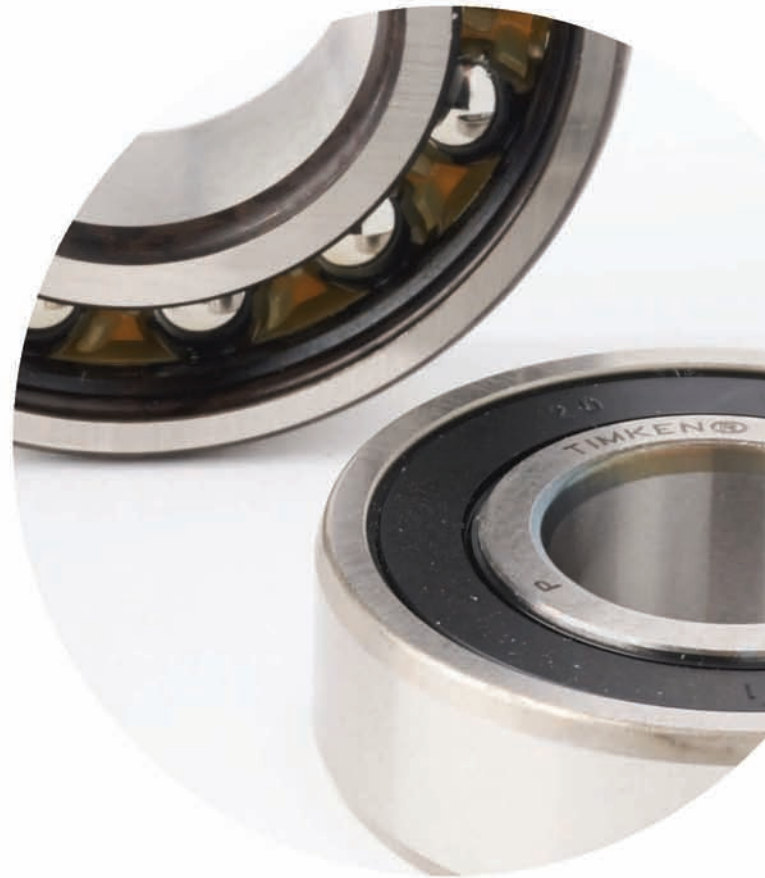

SHELF LIFE AND STORAGE OF GREASE-LUBRICATED BEARINGS AND COMPONENTS

To help you get the most value from our products, Timken provides guidelines for the shelf life of grease-lubricated ball and roller bearings, components and assemblies. Shelf life information is based on Timken and industry test data and experience.

SHELF LIFE POLICY

Shelf life should be distinguished from lubricated bearing/component design life as follows:

- Shelf life of the grease-lubricated bearing/component represents the period of time prior to use or installation.
- The shelf life is a portion of the anticipated aggregate design life. It is impossible to accurately predict design life due to variations in lubricant bleed rates, oil migration, operating conditions, installation conditions, temperature, humidity and extended storage.
- Shelf life values, available from Timken, represent a maximum limit and assume adherence to the storage and handling guidelines suggested in this catalog or by a Timken associate. Deviations from the Timken storage and handling guidelines may reduce shelf life. Any specification or operating practice that defines a shorter shelf life should be used.

Timken cannot anticipate the performance of the grease lubricant after the bearing or component is installed or placed in service.

TIMKEN IS NOT RESPONSIBLE FOR THE SHELF LIFE OF ANY BEARING/COMPONENT LUBRICATED BY ANOTHER PARTY.

European REACH Compliance

Timken lubricants, greases and similar products sold in standalone containers or delivery systems are subject to the European REACH (Registration, Evaluation, Authorization and Restriction of Chemicals) directive. For import into the European Union, Timken can sell and provide only those lubricants and greases that are registered with ECHA (European Chemical Agency). For further information, please contact your Timken sales engineer.

STORAGE

Timken suggests the following storage guidelines for its finished products:

- Unless directed otherwise by Timken, products should be kept in their original packaging until they are ready to be placed into service.
- Do not remove or alter any labels or stencil markings on the packaging.
- Products should be stored in such a way that the packaging is not pierced, crushed or otherwise damaged.
- After a product is removed from its packaging, it should be placed into service as soon as possible.
- When removing a product that is not individually packaged from a bulk pack container, the container should be resealed immediately after the product is removed.
- Do not use product that has exceeded its shelf life as defined in the Timken shelf life guidelines statement.
- The storage area temperature should be maintained between 0° C (32° F) and 40° C (104° F); temperature fluctuations should be minimized.
- The relative humidity should be maintained below 60 percent and the surfaces should be dry.
- The storage area should be kept free from airborne contaminants such as, but not limited to, dust, dirt, harmful vapors, etc.
- The storage area should be isolated from undue vibration.
- Extreme conditions of any kind should be avoided.

Due to the fact that Timken is not familiar with your particular storage conditions, we strongly suggest following these guidelines. However, you may be required by circumstances or applicable government requirements to adhere to stricter storage requirements.

Most bearing components typically ship protected with a corrosion-preventive compound that is not a lubricant. These components may be used in oil-lubricated applications without removal of the corrosion-preventive compound. When using some specialized grease lubrications, we advise you to remove the corrosion-preventive compound before packing the bearing components with suitable grease.

Be careful in selecting lubrication, however, since different lubricants are often incompatible.

When you receive a bearing shipment, do not remove products from their packaging until they are ready for mounting so they do not become corroded or contaminated.

Store bearings and bearing housings in an appropriate atmosphere so they remain protected for the intended period.



**WARNING**

Failure to observe the following warnings could create a risk of death or serious injury.

Proper maintenance and handling practices are critical. Always follow installation instructions and maintain proper lubrication.

Tensile stresses can be very high in tightly fitted bearing components. Attempting to remove such components by cutting the cone (inner race) may result in a sudden shattering of the component, causing fragments of metal to be forcefully expelled. Always use properly guarded presses or bearing pullers to remove bearings from shafts, and always use suitable personal protective equipment, including safety glasses.

CAUTION

Failure to follow these cautions may result in property damage.

The products catalogued are application-specific. Any use in applications other than those intended could lead to equipment failure or to reduced equipment life.

Use of improper bearing fits may cause damage to equipment.

Do not use damaged bearings. The use of a damaged bearing can result in equipment damage.

NOTE

Do not attempt to disassemble unitized bearings. Components may become damaged and affect the performance and service life of the bearing.

Do not mix components of matched assemblies. Mixing components can reduce the service life of the bearing.

NOT TO BE USED AS A DESIGN MANUAL.

This is not a manual for the selection of bearings for new applications. Whenever it is necessary to select Timken bearings for new applications, consult the Timken Engineering Manual (order no. 10424) or get in touch with the nearest office of The Timken Company.

Never use steam or hot water when cleaning the bearings because these methods can create rust or corrosion.

Do not heat components with an open flame.

Do not heat bearing beyond 120° C (250° F).

DISCLAIMER

This catalog is provided solely to give you analysis tools and data to assist you in your product selection. Product performance is affected by many factors beyond the control of Timken. Therefore, the suitability and feasibility of all product selection must be validated by you.

Timken products are sold subject to Timken's terms and conditions of sale, which include its limited warranty and remedy, may be found at <http://www.timken.com/termsandconditionsofsale>. Please consult with your Timken sales engineer for more information and assistance.

Every reasonable effort has been made to ensure the accuracy of the information in this writing, but no liability is accepted for errors, omissions or for any other reason.

COMPLIANCE

To view the complete engineering catalog, please visit www.timken.com. To order the catalog, please contact your Timken sales engineer and request a copy of the Timken Engineering Manual (order number 10424).

European REACH compliance *Timken-branded lubricants, greases and similar products sold in stand-alone containers or delivery systems are subject to the European REACH (Registration, Evaluation, Authorization and Restriction of CHemicals) directive. For import into the European Union, Timken can sell and provide only those lubricants and greases that are registered with ECHA (European CHemical Agency). For further information, please contact your Timken sales engineer.*

The Timken Company products shown in this catalog may be directly or indirectly subject to a number of regulatory standards and directives originating from authorities in the USA, European Union and around the world including: REACH (EC 1907/2006, RoHS (2011/65/EU), ATEX (94/9/EC), 'CE' MARKING (93/68/EEC), CONFLICT MINERALS (Section 1502 of the Dodd-Frank Wall Street Reform and Consumer Protection Act).

For any questions or concerns regarding the compliance or applicability of Timken products to these or other unspecified standards, please contact your Timken sales engineer or customer services representative.

Updates are made periodically to this catalog. Visit www.timken.com for the most recent version of the Timken® Deep Groove Ball Bearing Catalog.

ENGINEERING

This engineering section is not intended to be comprehensive, but does serve as a useful guide in deep groove ball bearing selection. To view the complete engineering catalog, please visit www.timken.com. To order the catalog, contact your Timken sales engineer and request a copy of the Timken Engineering Manual (order no.10424).

The following topics are covered within this section:

Bearing Size Range	14
Deep Groove Ball Bearing Types	14
Deep Groove Ball Bearing Configurations	14
Ball Bearing Cages	15
Shields and Seals.....	16
Lubrication	17
Bearing Life.....	18
Rating Life.....	18
Speed Rating.....	18
Radial Internal Clearance.....	19
Deep Groove Ball Bearing Tolerances.....	20
Fitting Practice	21



BEARING SIZE RANGE

Deep groove ball bearings are available in a variety of sizes and are the most popular of the rolling bearings. This type of bearing supports radial load and a small degree of axial load in both directions simultaneously. Deep groove ball bearings are popular due to their versatility, affordability, and capability to run at high speeds.

Timken offers deep groove ball bearings in a wide range of sizes and configurations. Offered sizes range from 3 mm to 160 mm bore, and maximum outside diameter of 250 mm. Timken continues to expand the offering of deep groove ball bearings with larger sizes to be introduced.

DEEP GROOVE BALL BEARING TYPES

There are several series of deep groove ball bearings that have been standardized by bearing manufacturers. The boundary dimensions for standard metric bearings are contained in the general plans as specified in ISO (International Organization for Standardization) standard 15:2011 for radial rolling bearings.

The Timken offering includes standard, thin section, narrow, wide, extra small and miniature constructions. Those are offered in several variations including the following:

- Open basic design
- With shields
- With contact seals
- With non-contact seals
- With a snap ring groove only
- With a snap ring on the outer ring O.D.

DEEP GROOVE BALL BEARING CONFIGURATIONS

Variations may differ based on bearing size and/or series. Details of the variations for each are listed in the product tables on pages 29–34.

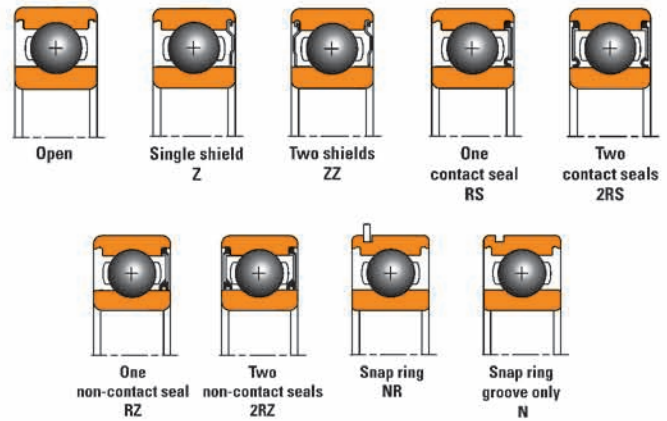

Fig. 1. Deep groove ball bearing variations.

BALL BEARING CAGES





Cages (also referred to as retainers) make a vital contribution to overall bearing performance. They maintain uniform ball spacing in the bearing as the balls pass into and out of the load zone.

Cages can impact several bearing operational characteristics such as:

- Maximum rotational speed
- Torque characteristics
- Temperature limits
- Lubricant flow

There are a number of different cage types that are commonly used in deep groove ball bearings, the most popular being the riveted steel cage. Table 1 below describes the most common ball bearing cage types.

TABLE 1. COMMON BALL BEARING CAGE TYPES

Type	Two-Piece Riveted Steel Cage	One-Piece Stainless Steel Crown Type Cage	Pressed-Steel Finger Type Cage	One-Piece Polymer Crown Type Cage	Machined-Brass Cage
Design					
Construction	Two pressed-steel half cages are fixed together with rivets; ball-piloted cage provides good uniformity of ball-to-pocket clearance.	Pressed stainless steel cage guided by inner ring.	Two pressed steel half cages fixed together by formed fingers.	One-piece molded snap-in 6/6 nylon cage.	Two identical half cages made from solid brass, fixed together with rivets.
Advantages	Designed to reduce frictional torque; high rigidity and strength, making it the cage of choice for most applications.	Best performance in low-speed applications where low torque is preferred.	General purpose ball-riding design.	Tough and flexible especially in situations of misalignment; resistant to most solvents, oils and greases.	Superior strength enables this cage to be used in heavily loaded and high-speed applications.

SHIELDS AND SEALS

Bearing seals and shields help prevent lubricant from leaking out, and prevent dust, water and other external contaminants from entering into the bearing.

Shielded Timken deep groove ball bearings are available with one shield, designated by suffix Z, or two shields, designated by suffix ZZ. A shield on one side provides protection against the entrance of coarse debris and makes it possible to re-lubricate the bearing from the open side.

Sealed deep groove ball bearings are available with one or two contact seals (suffix RS and 2RS), and with one or two non-contact seals (suffix RZ and 2RZ). Timken seals use high-performance Nitrile Buna Rubber (NBR) seal material reinforced by a low carbon steel case for standard operating temperatures. FKM (Viton®*) seals can be made available for higher operating temperatures.

Double shielded or sealed bearings are pre-lubricated with the correct amount of Timken suggested ball bearing grease and are designed for applications where re-lubrication is not required.

The following table summarizes the main characteristics of Timken ball bearing shields and seals.

TABLE 2. CHARACTERISTICS OF TIMKEN BALL BEARING SHIELDS AND SEALS

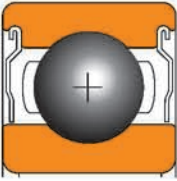
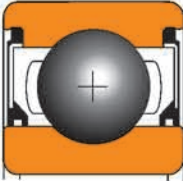
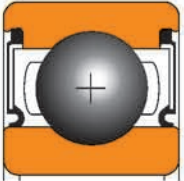
Type	Shields ZZ	Non-Contact Seals 2RZ	Contact Seals 2RS
Construction			
Material	Low carbon pressed steel	Nitrile Buna Rubber with steel case	Nitrile Buna Rubber with steel case
Speed Capability	High speed	High speed	Less than ZZ/2RZ due to seal contact
Operating Temperature	-50 to +120° C	-40 to +120° C	-40 to +120° C
Grease Retention	Good	Better than ZZ type	Excellent
Dust Resistance	Good	Better than ZZ type	Excellent
Torque	Low	Low	Higher than ZZ/2RZ due to seal contact

NOTE: The above operating temperature ranges are for standard shielded and sealed bearings. If higher temperature capability is needed, alternative bearing, grease or seal materials may be considered. Please contact your Timken sales engineer for such requirements.

*Viton® a registered trademark of DuPont Performance Elastomers L.L.C.

LUBRICATION

Ball bearings must be lubricated to minimize friction between balls and raceways, as well as between balls and cages. Lubricants also help to protect the bearings from corrosion and, in some cases, to dissipate heat.

Timken open ball bearings, as well as single-sealed/shielded bearings, are supplied with rust preventive (RP) covering all bearing surfaces. For such bearings, the end user selects and applies the desired lubrication type and quantity as required by the application.

Timken double-sealed and double-shielded deep groove ball bearings are factory pre-lubricated with water-resistant grease chosen for chemical and mechanical stability. The standard grease preferred by Timken for deep groove ball bearings is Mobil Polyrex™ EM. This is a mineral-oil based, advanced polyurea-thickened grease that maintains proper lubrication for a wide range of operating temperatures from -29° C to

177° C. Mobil Polyrex™ EM provides protection against rust and corrosion, and additional protection under mild salt-water wash conditions. This grease also is widely preferred in electric motor applications.

The standard factory grease fill is 30 percent to 50 percent for most Timken double-sealed/shielded ball bearings. This accommodates most applications. The type and amount of grease needed varies depending on operating conditions and bearing series. Most bearings can be filled with customer-specified greases upon request to meet specific application needs. Aside from Mobil Polyrex™ EM grease, Timken also offers a range of other proven and popular greases suitable for a wide range of applications.

Table 3 provides an overview of some of the most common greases available for general applications.

TABLE 3. COMMON DEEP GROOVE BALL BEARING GREASES

Product Name	Brand Name	Min Temp (° C)	Max Temp (° C)	Base Oil Type	Thickener	Color	Characteristics and Application
Mobil Polyrex™ EM	Mobil	-29	177	Mineral Oil	Polyurea	Blue	Electric motor grease; very good resistance to water/salt water
BEACON™ 325	Exxon	-54	121	Diester	Lithium Soap	Tan (Light)	Low torque, quiet running
Mobilgrease 28	Mobil	-54	177	Hydrocarbon (Synthetic)	Clay (Organic)	Red (Dark)	Wide temp range
Chevron SRI Grease 2	Chevron	-29	177	Mineral Oil	Polyurea	Green to Blue-Green	Electric motor grease; very good resistance to water/salt water
Multemp SRL	Kyodo Yushi	-40	149	Oil (Synthetic)	Lithium	Brown (Light)	Low torque, quiet running
Shell® Alvania EP No. 2	Shell	-10	149	Hydrocarbon (Synthetic)	Lithium Soap	Brown (Dark)	All-purpose grease

BEARING LIFE

The selection of the appropriate bearing for a given application is dependent on several performance criteria. These include bearing fatigue life, rotating precision, power requirement, temperature limits, speed capabilities and sound requirements. This section deals primarily with bearing life as related to material-associated fatigue.

Bearing life is defined as the length of time, or number of revolutions, until a fatigue spall of 6 mm² develops. Since fatigue is a statistical phenomenon, the life of an individual bearing is impossible to predetermine precisely. Bearings that may appear to be identical can exhibit considerable life scatter when tested under identical conditions. Thus, it is necessary to base life predictions on a statistical evaluation of a large number of bearings operating under similar conditions. The Weibull distribution function is the accepted standard for predicting the life of a population of bearings at any given reliability level.

RATING LIFE

Rating life (L_{10}) is the life that 90 percent of a group of apparently identical bearings will complete or exceed before a fatigue spall develops. The L_{10} life also is associated with 90 percent reliability for a single bearing under a certain load.

DYNAMIC LOAD RATING

Published dynamic load ratings for Timken ball bearings are based on the industry standard procedure outlined in ISO 281:2007. This rating, designated as C_r , is defined as the radial load under which a population of bearings will achieve a L_{10} life of one million revolutions. Radial load is assumed to be constant in magnitude and direction for radial ball bearings.

STATIC LOAD RATING

The basic static load rating for Timken bearings (designated as C_0) as defined in ISO 76:2006 is based on a maximum contact stress within a non-rotating bearing of 4200 MPa at the center of the most heavily loaded rolling element and raceway contact.

Such stress levels may cause visible light Brinell marks on the bearing raceways. This degree of marking will not have a measurable effect on fatigue life when the bearing is subsequently rotated under a lower application load. If sound, vibration or torque are critical or if a pronounced shock load is present, a lower load limit should be applied. For more information on selecting a bearing for static load conditions, consult your Timken sales engineer.

SPEED RATING

THERMAL REFERENCE SPEED

The thermal reference speed is the bearing thermal equilibrium speed based on industry standard reference conditions outlined in ISO 15312:2003. Thermal equilibrium balances the heat generated by the bearing, with heat conduction through the housing and shaft. This standard applies to both bath oil lubricated and 30 percent grease fill packed bearings. It excludes any heat removed by a circulating lubricant. This standard also excludes the outer ring rotating application and heat generated by contact seals.

The ISO 15312 thermal reference speed rating calculations are based on the following assumptions:

- The bearing ambient temperature is 20° C.
- The tolerable bearing/housing interface temperature is 70° C.
- Oil and grease lubricants are considered.
 - For radial bearings with oil lubrication: ISO VG 32 oil.
 - For radial bearings with grease lubrication: ISO VG 150 grease.
- The radial loads assume a normal clearance (C0 or CN).
- For radial bearings, the applied load is 5 percent of the static load rating (C_0).

Thermal reference speed ratings assume the bearing has been sufficiently broken in. During the break-in process, temperatures may exceed the tolerable limit. Break-in commonly takes between 10 to 36 hours.

Standard bearing materials and lubricants can generally withstand temperatures up to and beyond 100° C. For this reason, a permissible temperature of 100° C was assumed for the thermal speed rating calculation. Contact your Timken sales engineer if your application requires speeds above the Timken published values.

LIMITING SPEED

For certain ball bearing types and sizes, cage behavior becomes the limiting factor to bearing operating speed. For such bearings, the thermal speed rating per ISO 15312:2003 is not shown. Instead, Timken publishes limiting speeds for those bearings, as is the case for thin-section and extra-small deep groove ball bearings.

For bearings with contact seals, the speed rating also is impacted by the speed of the seal. In general, bearings with contact seals have speed ratings that are 50 percent to 60 percent of the published speed rating of the equivalent open bearing.

RADIAL INTERNAL CLEARANCE (RIC)

In the manufacture of ball bearings, it is standard practice to assemble rings and rolling elements with a specified internal clearance. This characteristic is necessary to absorb the loss of clearance due to press fitting the bearing rings at mounting or due to expansion of bearings, shafts and housings. Internal clearance in an application is an important factor that has a significant influence on bearing performance.

The radial internal clearance (RIC) in a deep groove ball bearing can be defined as the average outer ring raceway diameter minus the average inner-ring raceway diameter minus twice the ball diameter.

Internal clearance reduces due to press fitting the bearing rings on the shaft or in the housing. This reduced internal clearance in the bearings at mounted condition is called mounted radial internal clearance.

RIC OF MINIATURE AND EXTRA SMALL DEEP GROOVE BALL BEARINGS < 10 MM BORE

The RIC symbols for miniature and extra small deep groove ball bearings with bore size less than 10 mm are as follows:

- MC1 – Extra tight
- MC2 – Tight
- MC3 – Normal or regular
- MC4 – Loose
- MC5 – Extra loose
- MC6 – Extra-extra loose

Table 4 provides the selection of RIC for miniature and extra small deep groove ball bearings.

TABLE 4. RADIAL INTERNAL CLEARANCE – MINIATURE AND EXTRA SMALL DEEP GROOVE BALL BEARINGS < 10 MM BORE

Radial Internal Clearance											
MC1		MC2		MC3		MC4		MC5		MC6	
Min.	Max.	Min.	Max.	Min.	Max.	Min.	Max.	Min.	Max.	Min.	Max.
µm		µm		µm		µm		µm		µm	
0	5	3	8	5	10	8	13	13	20	20	28

Standard miniature and extra-small deep groove ball bearings (< 10 mm bore) with no clearance designation in the part number are made with the MC3 normal clearance.

RIC OF DEEP GROOVE BALL BEARINGS ≥ 10 MM BORE

The RIC designations for standard deep groove ball bearings (≥ 10 mm bore) are as follows:

- C2 – Tight
- CN or C0 – Normal or regular
- C3 – Loose
- C4 – Extra loose
- C5 – Extra-extra loose

Table 5 below provides the selection of bearing internal clearances for deep groove ball bearings with bore size 10 mm and above.

TABLE 5. RADIAL INTERNAL CLEARANCE – DEEP GROOVE BALL BEARINGS ≥ 10 MM BORE

Bore Diameter (d)	Radial Internal Clearance										
	C2		CN or C0		C3		C4		C5		
	Over	Incl.	Min.	Max.	Min.	Max.	Min.	Max.	Min.	Max.	
mm		µm		µm		µm		µm		µm	
only 10		0	7	2	13	8	23	14	29	20	37
10	18	0	9	3	18	11	25	18	33	25	45
18	24	0	10	5	20	13	28	20	36	28	48
24	30	1	11	5	20	13	28	23	41	30	53
30	40	1	11	6	20	15	33	28	46	40	64
40	50	1	11	6	23	18	36	30	51	45	73
50	65	1	15	8	28	23	43	38	61	55	90
65	80	1	15	10	30	25	51	46	71	65	105
80	100	1	18	12	36	30	58	53	84	75	120
100	120	2	20	15	41	36	66	61	97	90	140
120	140	2	23	18	48	41	81	71	114	105	160
140	160	2	23	18	53	46	91	81	130	120	180
160	180	2	25	20	61	53	102	91	147	135	200
180	200	2	30	25	71	63	117	107	163	150	230
200	225	2	35	25	85	75	140	125	195	175	265

DEEP GROOVE BALL BEARING TOLERANCES

Ball bearings are manufactured to a number of specifications, with each having classes that define tolerances on dimensions such as bore, outer diameter, width and runout.

Standard Timken deep groove ball bearings maintain normal tolerances (P0) according to the current ISO 492 standard. For applications where running tolerance is critical, P6 or P5 tolerances are recommended.

The term “deviation” is defined as the difference between a single ring dimension and the nominal dimension. For metric tolerances, the normal dimension is at a +0 mm tolerance. The deviation is the tolerance range for the listed parameter. Variation is defined as the difference between the largest and smallest measurement of a given parameter for an individual ring.

Tables 6 and 7 provide tolerances for deep groove ball bearing inner and outer rings respectively.

TABLE 6. RADIAL BALL BEARING TOLERANCES – INNER RING

Bearing Bore		Bore Deviation	Width Variation	Radial Runout	Face Runout with Bore	Axial Runout	Width Deviation Inner and Outer Rings	
d		Δd_{mp}	V_{BS}	K_{ia}	S_a	S_{ia}	ΔBs and ΔCs	
over	incl.	P0	P0, P6	P0	P5	P5	P0, P6	P5
mm	mm	μm	μm	μm	μm	μm	μm	μm
2.5	10	-8	15	10	7	7	-120	-40
10	18	-8	20	10	7	7	-120	-80
18	30	-10	20	13	8	8	-120	-120
30	50	-12	20	15	8	8	-120	-120
50	80	-15	25	20	8	8	-150	-150
80	120	-20	25	25	9	9	-200	-200
120	150	-25	30	30	10	10	-250	-250
150	180	-25	30	30	10	10	-250	-250
180	250	-30	30	40	11	13	-300	-300
250	315	-35	35	50	13	15	-350	-350
315	400	-40	40	60	15	20	-400	-400

TABLE 7. RADIAL BALL BEARING TOLERANCES – OUTER RING

Bearing O.D.		Outside Deviation	Width Variation	Radial Runout	Axial Runout	Outside Diameter Runout With Face
D		ΔD_{mp}	V_{CS}	K_{ea}	S_{ea}	S_D
over	incl.	P0	P0	P0	P5	P5
mm	mm	μm	μm	μm	μm	μm
6	18	-8	15	15	8	8
18	30	-9	15	15	8	8
30	50	-11	20	20	8	8
50	80	-13	25	25	10	8
80	120	-15	25	35	11	9
120	150	-18	30	40	13	10
150	180	-25	30	45	14	10
180	250	-30	30	50	15	11
250	315	-35	35	60	18	13
315	400	-40	40	70	20	13
400	500	-45	45	80	23	15
500	630	-50	50	100	25	18

FITTING PRACTICE

As a general guideline, bearing rings mounted on a rotating member should have an interference fit. Loose fits may permit the ring to creep or turn, and wear the mating surface and backing shoulder. This wear can result in excessive bearing looseness and damage the bearing, shaft or housing.

The choice of fitting practices will mainly depend upon the following parameters:

- Precision class of the bearing.
- Rotating or stationary ring.
- Type of layout (single- or double-row bearings).
- Type and direction of load (continuous/alternate rotating).
- Particular running conditions like shocks, vibrations, overloading or high speed.
- Capability for machining the seats (grinding, turning or boring).
- Shaft and housing section and material.
- Mounting and setting conditions.

Fig. 2 is a graphical representation of roller bearing shaft and housing fit selection that conforms to accepted industry standards and practices. The bars designated g6, h6, etc., represent shaft/housing diameter and tolerance ranges to achieve various loose and interference fits required for various load and ring rotation conditions.

Tables 8 and 9 provide the resultant fits for deep groove ball bearings based on standard ISO tolerances for shaft and housing.

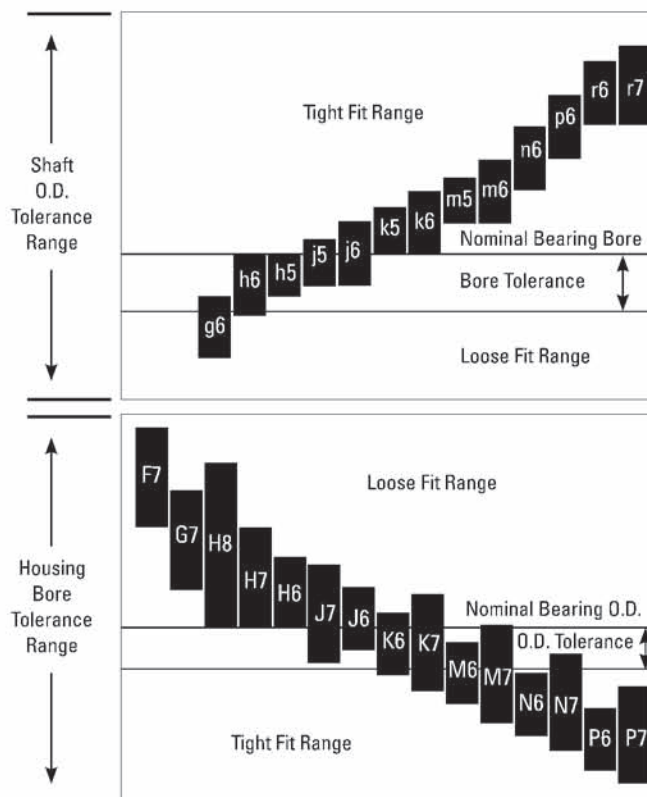

Fig. 2. Shaft and housing fit selection.

TABLE 8. SHAFT TOLERANCES: RADIAL BALL BEARINGS

Bearing Bore		g6		h5		h6		j5		js5		js6		j6	
Nominal (Max.)	Tolerance	Shaft Diameter	Fit	Shaft Diameter	Fit	Shaft Diameter	Fit	Shaft Diameter	Fit	Shaft Diameter	Fit	Shaft Diameter	Fit	Shaft Diameter	Fit
Over Incl.	Max. Min.	Max. Min.		Max. Min.		Max. Min.		Max. Min.		Max. Min.		Max. Min.		Max. Min.	
mm	µm	µm		µm		µm		µm		µm		µm		µm	
- 3	0 -8	-2 -8	8L 6T	0 -4	4L 8T	0 -6	6L 8T	2 -2	2L 10T	2 -2	2L 10T	3 -3	3L 11T	4 -2	2L 12T
3 6	0 -8	-4 -12	12L 4T	0 -5	5L 8T	0 -8	8L 8T	3 -2	2L 11T	2.5 -2.5	2.5L 10.5T	4 -4	4L 12T	6 -2	2L 14T
6 10	0 -8	-5 -14	14L 3T	0 -6	6L 8T	0 -9	9L 8T	4 -2	2L 12T	3 -3	3L 11T	4.5 -4.5	4.5L 12.5T	7 -2	2L 15T
10 18	0 -8	-6 -17	17L 2T	0 -8	8L 8T	0 -11	11L 8T	5 -3	3L 13T	4 -4	4L 12T	5.5 -5.5	5.5L 13.5T	8 -3	3L 16T
18 30	0 -10	-7 -20	20L 3T	0 -9	9L 10T	0 -13	13L 10T	5 -4	4L 15T	4.5 -4.5	4.5L 14.5T	6.5 -6.5	6.5L 16.5T	9 -4	4L 19T
30 50	0 -12	-9 -25	25L 3T	0 -11	11L 12T	0 -16	16L 12T	6 -5	5L 18T	5.5 -5.5	5.5L 17.5T	8 -8	8L 20T	11 -5	5L 23T
50 80	0 -15	-10 -29	29L 5T	0 -13	13L 15T	0 -19	19L 15T	6 -7	7L 21T	6.5 -6.5	6.5L 21.5T	9.5 -9.5	9.5L 24.5T	12 -7	7L 27T
80 120	0 -20	-12 -34	34L 8T	0 -15	15L 20T	0 -22	22L 20T	6 -9	9L 26T	7.5 -7.5	7.5L 27.5T	11 -11	11L 31T	13 -9	9L 33T
120 180	0 -25	-14 -39	39L 11T	0 -18	18L 25T	0 -25	25L 25T	7 -11	11L 32T	9 -9	9L 34T	12.5 -12.5	12.5L 37.5T	14 -11	11L 39T
180 200	0 -30	-15 -44	44L 15T	0 -20	20L 30T	0 -29	29L 30T	7 -13	13L 37T	10 -10	10L 40T	14.5 -14.5	14.5L 44.5T	16 -13	13L 46T
200 225	0 -30	-15 -44	44L 15T	0 -20	20L 30T	0 -29	29L 30T	7 -13	13L 37T	10 -10	10L 40T	14.5 -14.5	14.5L 44.5T	16 -13	13L 46T
225 250	0 -30	-15 -44	44L 15T	0 -20	20L 30T	0 -29	29L 30T	7 -13	13L 37T	10 -10	10L 40T	14.5 -14.5	14.5L 44.5T	16 -13	13L 46T
250 280	0 -35	-17 -49	49L 18T	0 -23	23L 35T	0 -32	32L 35T	7 -16	16L 42T	11.5 -11.5	11.5L 46.5T	16 -16	16L 51T	16 -16	16L 51T
280 315	0 -35	-17 -49	49L 18T	0 -23	23L 35T	0 -32	32L 35T	7 -16	16L 42T	11.5 -11.5	11.5L 46.5T	16 -16	16L 51T	16 -16	16L 51T
315 355	0 -40	-18 -54	54L 22T	0 -25	25L 40T	0 -36	36L 40T	7 -18	18L 47T	12.5 -12.5	12.5L 52.5T	18 -18	18L 58T	18 -18	18L 58T
355 400	0 -40	-18 -54	54L 22T	0 -25	25L 40T	0 -36	36L 40T	7 -18	18L 47T	12.5 -12.5	12.5L 52.5T	18 -18	18L 58T	18 -18	18L 58T
400 450	0 -45	-20 -60	60L 25T	0 -27	27L 45T	0 -40	40L 45T	7 -20	20L 52T	13.5 -13.5	13.5L 58.5T	20 -20	20L 65T	20 -20	20L 65T
450 500	0 -45	-20 -60	60L 25T	0 -27	27L 45T	0 -40	40L 45T	7 -20	20L 52T	13.5 -13.5	13.5L 58.5T	20 -20	20L 65T	20 -20	20L 65T
500 560	0 -50	-22 -66	66L 28T	0 -28	28L 50T	0 -44	44L 50T	8 -22	22L 58T	14 -14	14L 64T	22 -22	22L 72T	-22 -22	22L 72T
560 630	0 -50	-22 -66	66L 28T	0 -28	28L 50T	0 -44	44L 50T	8 -22	22L 58T	14 -14	14L 64T	22 -22	22L 72T	-22 -22	22L 72T
630 710	0 -75	-24 -74	74L 51T	0 -32	32L 75T	0 -50	50L 75T	10 -25	25L 85T	16 -16	16L 91T	25 -25	25L 100T	25 -25	25L 100T
710 800	0 -75	-24 -74	74L 51T	0 -32	32L 75T	0 -50	50L 75T	10 -25	25L 85T	16 -16	16L 91T	25 -25	25L 100T	25 -25	25L 100T
800 900	0 -100	-26 -82	82L 74T	0 -36	36L 100T	0 -56	56L 100L	12 -28	28L 112T	18 -18	18L 118T	28 -28	28L 128T	28 -28	28L 128T
900 1000	0 -100	-26 -82	82L 74T	0 -36	36L 100T	0 -56	56L 100L	12 -28	28L 112T	18 -18	18L 118T	28 -28	28L 128T	28 -28	28L 128T
1000 1120	0 -125	-28 -94	94L 97T	0 -42	42L 125T	0 -66	66L 125T	13 -33	33L 138T	21 -21	21L 146T	33 -33	33L 158T	33 -33	33L 158T
1120 1250	0 -125	-28 -94	94L 97T	0 -42	42L 125T	0 -66	66L 125T	13 -33	33L 138T	21 -21	21L 146T	33 -33	33L 158T	33 -33	33L 158T

k5			k6		m5		m6		n6		p6		r6		r7								
Shaft Diameter	Fit		Shaft Diameter	Fit	Shaft Diameter	Fit	Shaft Diameter	Fit	Shaft Diameter	Fit	Shaft Diameter	Fit	Shaft Diameter	Fit	Shaft Diameter	Fit							
Max. Min.			Max. Min.		Max. Min.		Max. Min.		Max. Min.		Max. Min.		Max. Min.		Max. Min.								
μm			μm		μm		μm		μm		μm		μm		μm								
4	0	0T 12T	6	0	0T 14T	6	2	2T 14T	8	2	2T 16T	-	-	-	-	-							
6	1	1T 14T	9	1	1T 17T	9	4	4T 17T	12	4	4T 20T	16	8	8T 24T	20	12	12T 28T	23	15	15T 31T	27	15	15T 35T
7	1	1T 15T	10	1	1T 18T	12	6	6T 20T	15	6	6T 23T	19	10	10T 27T	24	15	15T 32T	28	19	19T 36T	34	19	19T 42T
9	1	1T 17T	12	1	1T 20T	15	7	7T 23T	18	7	7T 26T	23	12	12T 31T	29	18	18T 37T	34	23	23T 42T	41	23	23T 49T
11	2	2T 21T	15	2	2T 25T	17	8	8T 27T	21	8	8T 31T	28	15	15T 38T	35	22	22T 45T	41	28	28T 49T	49	28	28T 59T
13	2	2T 25T	18	2	2T 30T	20	9	9T 32T	25	9	9T 37T	33	17	17T 45T	42	26	26T 54T	50	34	34T 62T	59	34	34T 71T
15	2	2T 30T	21	2	2T 36T	24	11	11T 39T	30	11	11T 45T	39	20	20T 54T	51	32	32T 66T	62	41	41T -77T	73	41	41T 88T
18	3	3T 38T	25	3	3T 45T	28	13	13T 48T	35	13	13T 55T	45	23	23T 65T	59	37	37T 79T	76	51	51T 96T	89	51	51T 109T
21	3	3T 46T	28	3	3T 53T	33	15	15T 58T	40	15	15T 65T	52	27	27T 77T	68	43	43T 93T	90	65	65T 115T	105	65	65T 130T
24	4	4T 54T	33	4	4T 63T	37	17	17T 67T	46	17	17T 76T	60	31	31T 90T	79	50	50T 109T	106	77	77T 136T	123	77	77T 153T
24	4	4T 54T	33	4	4T 63T	37	17	17T 67T	46	17	17T 76T	60	31	31T 90T	79	50	50T 109T	109	80	80T 139T	126	80	80T 156T
24	4	4T 54T	33	4	4T 63T	37	17	17T 67T	46	17	17T 76T	60	31	31T 90T	79	50	50T 109T	113	84	84T 143T	130	84	84T 160T
27	4	4T 62T	36	4	4T 71T	43	20	20T 78T	52	20	20T 87T	66	34	34T 101T	88	56	56T 123T	126	94	94T 161T	146	94	94T 181T
27	4	4T 62T	36	4	4T 71T	43	20	20T 78T	52	20	20T 87T	66	34	34T 101T	88	56	56T 123T	130	98	98T 165T	150	98	98T 185T
29	4	4T 69T	40	4	4T 80T	46	21	21T 86T	57	21	21T 97T	73	37	37T 113T	98	62	62T 138T	144	108	108T 184T	165	108	108T 205T
29	4	4T 69T	40	4	4T 80T	46	21	21T 86T	57	21	21T 97T	73	37	37T 113T	98	62	62T 138T	150	114	114T 190T	171	114	114T 211T
32	5	5T 77T	45	5	5T 90T	50	23	23T 95T	63	23	23T 108T	80	40	40T 125T	108	68	68T 153T	166	126	126T 211T	189	126	126T 234T
32	5	5T 77T	45	5	5T 90T	50	23	23T 95T	63	23	23T 108T	80	40	40T 125T	108	68	68T 153T	172	132	132T 217T	195	132	132T 240T
29	0	0T 79T	44	0	0T 94T	56	26	26T 105T	70	26	26T 120T	88	44	44T 138T	122	78	78T 172T	194	150	150T 244T	220	150	150T 270T
29	0	0T 79T	44	0	0T 94T	56	26	26T 105T	70	26	26T 120T	88	44	44T 138T	122	78	78T 172T	199	155	155T 249T	225	155	155T 275T
32	0	0T 107T	50	0	0T 125T	62	30	30T 137T	80	30	30T 155T	100	50	50T 175T	138	88	88T 213T	225	175	175T 300T	255	175	175T 330T
32	0	0T 107T	50	0	0T 125T	62	30	30T 137T	80	30	30T 155T	100	50	50T 175T	138	88	88T 213T	235	185	185T 310T	265	185	185T 340T
36	0	0T 136T	56	0	0T 156T	70	34	34T 170T	90	34	34T 190T	112	56	56T 212T	156	100	100T 256T	266	210	210T 366T	300	210	210T 400T
36	0	0T 136T	56	0	0T 156T	70	34	34T 170T	90	34	34T 190T	112	56	56T 212T	156	100	100T 256T	276	220	220T 376T	310	220	220T 410T
42	0	0T 167T	66	0	0T 191T	82	40	40T 207T	106	40	40T 231T	132	66	66T 257T	186	120	120T 311T	316	250	250T 441T	355	250	250T 480T
42	0	0T 167T	66	0	0T 191T	82	40	40T 207T	106	40	40T 231T	132	66	66T 257T	186	120	120T 311T	326	260	260T 451T	365	260	260T 490T

TABLE 9. HOUSING TOLERANCES: RADIAL BALL BEARINGS

Bearing O.D.		F7			G7			H6			H7			H8			J6			J7										
Nominal (Max.)	Tolerance	Housing Bore		Fit	Housing Bore		Fit	Housing Bore		Fit	Housing Bore		Fit	Housing Bore		Fit	Housing Bore		Fit	Housing Bore		Fit								
		Max.	Min.		Max.	Min.		Max.	Min.		Max.	Min.		Max.	Min.		Max.	Min.		Max.	Min.		Max.	Min.	Max.	Min.				
mm	µm	µm	µm		µm	µm		µm	µm		µm	µm		µm	µm		µm	µm		µm	µm									
6	10	0	-8	28	13	13L 32L		20	5	5L 28L		9	0	0L 17L		15	0	0L 23L		22	0	0L 30L		5	-4	4T 13L		8	-7	7T 16L
10	18	0	-8	34	16	16L 42L		24	6	6L 32L		11	0	0L 19L		18	0	0L 26L		27	0	0L 35L		6	-5	5T 14L		10	-8	8T 18L
18	30	0	-9	41	20	20L 50L		28	7	7L 37L		13	0	0L 22L		21	0	0L 30L		33	0	0L 42L		8	-5	5T 10 17L		12	-9	9T 21L
30	50	0	-11	50	25	25L 61L		34	9	9L 45L		16	0	0L 27L		25	0	0L 36L		39	0	0L 50L		10	-6	6T 21L		14	-11	11T 25L
50	80	0	-13	60	30	30L 73L		40	10	10L 53L		19	0	0L 32L		30	0	0L 43L		46	0	0L 59L		13	-6	6T 26L		18	-12	12T 31L
80	120	0	-15	71	36	36L 86L		47	12	12L 62L		22	0	0L 37L		35	0	0L 50L		54	0	0L 69L		16	-6	6T 31L		22	-13	13T 37L
120	150	0	-18	83	43	43L 101L		54	14	14L 72L		25	0	0L 43L		40	0	0L 58L		63	0	0L 81L		18	-7	7T 36L		26	-14	14T 44L
150	180	0	-25	83	43	43L 108L		54	14	14L 79L		25	0	0L 50L		40	0	0L 65L		63	0	0L 88L		18	-7	7T 43L		26	-14	14T 51L
180	250	0	-30	96	50	50L 126L		61	15	15L 91L		29	0	0L 59L		46	0	0L 76L		72	0	0L 102L		22	-7	7T 52L		30	-16	16T 60L
250	315	0	-35	108	56	56L 143L		69	17	17L 104L		32	0	0L 67L		52	0	0L 87L		81	0	0L 116L		25	-7	7T 60L		36	-16	16T 71L
315	400	0	-40	119	62	62L 159L		75	18	18L 115L		36	0	0L 76L		57	0	0L 97L		89	0	0L 129L		29	-7	7T 69L		39	-18	18T 79L
400	500	0	-45	131	68	68L 176L		83	20	20L 128L		40	0	0L 85L		63	0	0L 108L		97	0	0L 142L		33	-7	7T 78L		43	-20	20T 88L
500	630	0	-50	146	76	76L 196L		92	22	22L 142L		44	0	0L 94L		70	0	0L 120L		110	0	0L 160L		37	-7	7T 87L		48	-22	22T 98L
630	800	0	-75	160	80	80L 235L		104	24	24L 179L		50	0	0L 125L		80	0	0L 155L		125	0	0L 200L		40	-10	10T 115L		56	-24	24T 131L
800	1000	0	-100	176	86	86L 276L		116	26	26L 216L		56	0	0L 156L		90	0	0L 190L		140	0	0L 240L		46	-10	10T 146L		64	-26	26T 164L
1000	1250	0	-125	203	98	98L 328L		133	28	28L 258L		66	0	0L 191L		105	0	0L 230L		165	0	0L 290L		56	-10	10T 181L		77	-28	28T 202L
1250	1600	0	-160	235	110	110L 395L		155	30	30L 315L		78	0	0L 238L		125	0	0L 285L		195	0	0L 355L		68	-10	10T 228L		95	-30	30T 255L
1600	2000	0	-200	270	120	120L 470L		182	32	32L 382L		92	0	0L 292L		150	0	0L 350L		230	0	0L 430L		82	-10	10T 282L		118	-32	32T 318L
2000	2500	0	-250	305	130	130L 555L		209	34	34L 459L		110	0	0L 360L		175	0	0L 425L		280	0	0L 530L		100	-10	10T 350L		141	-34	34T 391L

JS6			K6			K7			M6			M7			N6			N7			P6			P7		
Housing Bore	Fit		Housing Bore	Fit		Housing Bore	Fit		Housing Bore	Fit		Housing Bore	Fit		Housing Bore	Fit		Housing Bore	Fit		Housing Bore	Fit		Housing Bore	Fit	
Max. Min.			Max. Min.			Max. Min.			Max. Min.			Max. Min.			Max. Min.			Max. Min.			Max. Min.			Max. Min.		
µm	µm		µm	µm		µm	µm		µm	µm		µm	µm		µm	µm		µm	µm		µm	µm		µm	µm	
4.5	-4.5	4.5T 12.5L	2	-7	7T 10L	5	-10	10T 13L	-3	-12	12T 5L	0	-15	15T 8L	-7	-16	16T 1L	-4	-19	19T 4L	-12	-21	21T 4T	-9	-24	24T 1T
5.5	-5.5	5.5T 13.5L	2	-9	9T 10L	6	-12	12T 14L	-4	-15	15T 4L	0	-18	18T 8L	-9	-20	20T 1T	-5	-23	23T 3L	-15	-26	26T 7T	-11	-29	29T 3T
6.5	-6.5	6.5T 15.5L	2	-11	11T 11L	6	-15	15T 15L	-4	-17	17T 5L	0	-21	21T 9L	-11	-24	24T 2T	-7	-28	28T 2L	-18	-31	31T 9T	-14	-35	35T 5T
8	-8	8T 19L	3	-13	13T 14L	7	-18	18T 18L	-4	-20	20T 7L	0	-25	25T 11L	-12	-28	28T 1T	-8	-33	33T 3L	-21	-37	37T 10T	-17	-42	42T 6T
9.5	-9.5	9.5T 22.5L	4	-15	15T 17L	9	-21	21T 22L	-5	-24	24T 8L	0	-30	30T 13L	-14	-33	33T 1T	-9	-39	39T 4L	-26	-45	45T 13T	-21	-51	51T 8T
11	-11	11T 26L	4	-18	18T 19L	10	-25	25T 25L	-6	-28	28T 9L	0	-35	35T 15L	-16	-38	38T 1T	-10	-45	45T 5L	-30	-52	52T 15T	-24	-59	59T 9T
12.5	-12.5	12.5T 30.5L	4	-21	21T 22L	12	-28	28T 30L	-8	-33	33T 10L	0	-40	40T 18L	-20	-45	45T 2T	-12	-52	52T 6L	-36	-61	61T 18T	-28	-68	68T 10T
12.5	-12.5	12.5T 37.5L	4	-21	21T 29L	12	-28	28T 37L	-8	-33	33T 17L	0	-40	40T 25L	-20	-45	45T 5L	-12	-52	52T 13L	-36	-61	61T 11T	-28	-68	68T 3T
14.5	-14.5	14.5T 44.5L	5	-24	24T 35L	13	-33	33T 43L	-8	-37	37T 22L	0	-46	46T 30L	-22	-51	51T 8L	-14	-60	60T 16L	-41	-70	70T 11T	-33	-79	79T 3T
16	-16	16T 51L	5	-27	27T 40L	16	-36	36T 51L	-9	-41	41T 26L	0	-52	52T 35L	-25	-57	57T 10L	-14	-66	66T 21L	-47	-79	79T 12T	-36	-88	88T 1T
18	-18	18T 58L	7	-29	29T 47L	17	-40	40T 57L	-10	-46	46T 30L	0	-57	57T 40L	-26	-62	62T 14L	-16	-73	73T 24L	-51	-87	87T 11T	-41	-98	98T 1T
20	-20	20T 65L	8	-32	32T 53L	18	-45	45T 63L	-10	-50	50T 35L	0	-63	63T 45L	-27	-67	67T 18L	-17	-80	80T 28L	-55	-95	95T 10T	-45	-108	108T 0T
22	-22	22T 72L	0	-44	44T 50L	0	-70	70T 50L	-26	-70	70T 24L	-26	-96	96T 24L	-44	-88	88T 6L	-44	-114	114T 6L	-78	-122	122T 28T	-78	-148	148T 28T
25	-25	25T 100L	0	-50	50T 75L	0	-80	80T 75L	-30	-80	80T 45L	-30	-110	110T 45L	-50	-100	100T 25L	-50	-130	130T 25L	-88	-138	138T 13T	-88	-168	168T 13T
28	-28	28T 128L	0	-56	56T 100L	0	-90	90T 100L	-34	-90	90T 66L	-34	-124	124T 66L	-56	-112	112T 44L	-56	-146	146T 44L	-100	-156	156T 0T	-100	-190	190T 0T
33	-33	33T 158L	0	-66	66T 125L	0	-105	105T 125L	-40	-106	106T 85L	-40	-145	145T 85L	-66	-132	132T 59L	-66	-171	171T 59L	-120	-186	186T 5L	-120	-225	225T 5L
39	-39	39T 199L	0	-78	78T 160L	0	-125	125T 160L	-48	-126	126T 112L	-48	-173	173T 112L	-78	-156	156T 82L	-78	-203	203T 82L	-140	-218	218T 20L	-140	-265	265T 20L
46	-46	46T 246L	0	-92	92T 200L	0	-150	150T 200L	-58	-150	150T 142L	-58	-208	208T 142L	-92	-184	184T 108L	-92	-242	242T 108L	-170	-262	262T 30L	-170	-320	320T 30L
55	-55	55T 305L	0	-110	110T 250L	0	-175	175T 250L	-68	-178	178T 182L	-68	-243	243T 182L	-110	-220	220T 140L	-110	-285	285T 140L	-195	-305	305T 55L	-195	-370	370T 55L

DEEP GROOVE BALL BEARINGS

The basic designation for deep groove ball bearings consists of the code for the bearing series and bore, as well as seal/shield and internal clearance designations if featured in the bearing design.

Nomenclature.....	28
Standard 6000 Series.....	29
61000 Thin-Section Series.....	31
16000 Narrow Series.....	32
62000-63000 Wide Series.....	33
Extra-Small 600 Series.....	34



NOMENCLATURE

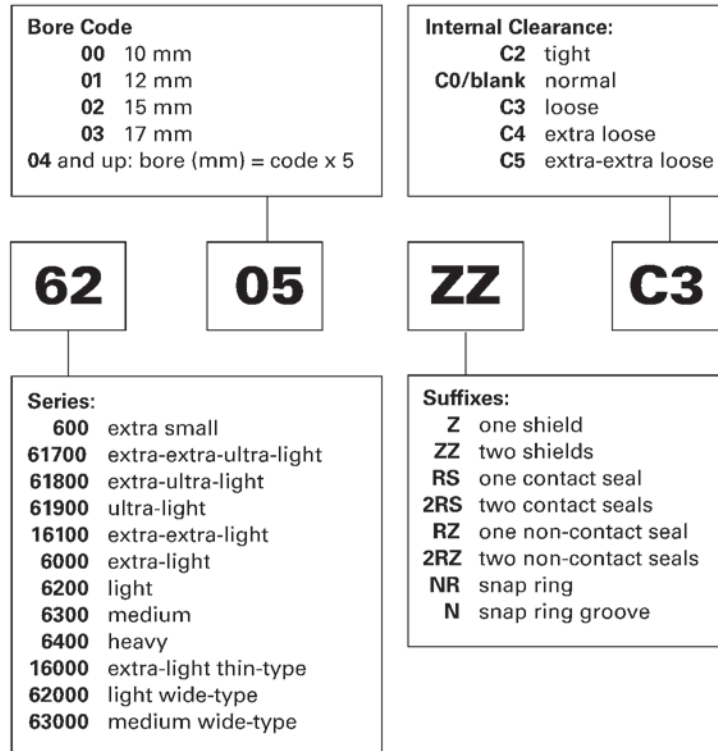

Fig. 3. Deep groove ball bearing nomenclature.

STANDARD 6000 SERIES

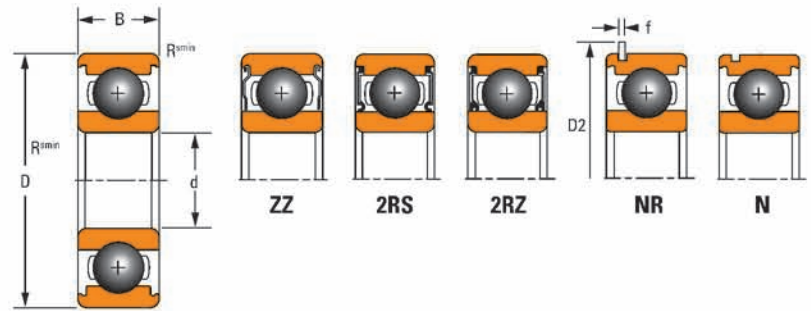

TABLE 10. STANDARD 6000 SERIES

Description	Bearing No. Features					Boundary Dimensions						Load Ratings		Reference Speed		Weight										
	Shields	Contact Seals	Non-Contact Seals	O.D. Groove	Snap Ring	Bore	O.D.	Width	Radius			Dynamic	Static	Grease	Oil											
						d	D	B	R _{s min}	D _{2 max}	f _{max}	C _r	C _{0r}	RPM	RPM											
																mm	mm	mm	mm	mm	mm	kN	kN	RPM	RPM	kg
6000	ZZ	2RS	2RZ	N	NR	10	26	8	0.3	29.2	0.70	4.60	2.00	26000	38000	0.020										
6200	ZZ	2RS	2RZ	N	NR	10	30	9	0.6	34.7	1.12	5.10	2.40	22000	32000	0.030										
6300	ZZ	2RS	2RZ	N	NR	10	35	11	0.6	39.7	1.12	8.10	3.40	20000	29000	0.050										
6001	ZZ	2RS	2RZ	N	NR	12	28	8	0.3	30.8	0.85	5.00	2.40	23000	33000	0.020										
6201	ZZ	2RS	2RZ	N	NR	12	32	10	0.6	36.7	1.12	6.80	3.00	21000	30000	0.040										
6301	ZZ	2RS	2RZ	N	NR	12	37	12	1.0	41.3	1.12	9.70	4.20	19000	27000	0.060										
6002	ZZ	2RS	2RZ	N	NR	15	32	9	0.3	36.7	1.12	5.60	2.80	20000	30000	0.030										
6202	ZZ	2RS	2RZ	N	NR	15	35	11	0.6	39.7	1.12	7.60	3.70	19000	28000	0.050										
6302	ZZ	2RS	2RZ	N	NR	15	42	13	1.0	46.3	1.12	11.30	5.40	16000	24000	0.080										
6003	ZZ	2RS	2RZ	N	NR	17	35	10	0.3	39.7	1.12	6.00	3.30	19000	28000	0.040										
6203	ZZ	2RS	2RZ	N	NR	17	40	12	0.6	44.6	1.12	9.60	4.80	17000	25000	0.070										
6303	ZZ	2RS	2RZ	N	NR	17	47	14	1.0	52.7	1.12	13.50	6.60	15000	22000	0.120										
6004	ZZ	2RS	2RZ	N	NR	20	42	12	0.6	46.3	1.12	9.40	5.00	17000	25000	0.070										
6204	ZZ	2RS	2RZ	N	NR	20	47	14	1.0	52.7	1.12	12.80	6.60	15000	22000	0.100										
6304	ZZ	2RS	2RZ	N	NR	20	52	15	1.1	57.9	1.12	15.90	7.90	13000	20000	0.140										
6005	ZZ	2RS	2RZ	N	NR	25	47	12	0.6	52.7	1.12	10.10	5.80	14000	21000	0.080										
6205	ZZ	2RS	2RZ	N	NR	25	52	15	1.0	57.9	1.12	14.00	7.90	14000	20000	0.130										
6305	ZZ	2RS	2RZ	N	NR	25	62	17	1.1	67.7	1.70	22.40	11.50	12000	17000	0.220										
6405	-	-	-	N	NR	25	80	21	1.5	86.6	1.70	36.10	18.80	10000	15000	0.530										
6006	ZZ	2RS	2RZ	N	NR	30	55	13	1.0	60.7	1.12	13.20	8.30	12000	18000	0.110										
6206	ZZ	2RS	2RZ	N	NR	30	62	16	1.0	67.7	1.70	19.50	11.30	11000	16000	0.200										
6306	ZZ	2RS	2RZ	N	NR	30	72	19	1.1	78.6	1.70	26.60	15.00	10000	15000	0.350										
6406	-	-	-	N	NR	30	90	23	1.5	96.5	2.46	47.30	24.50	9300	13000	0.740										
6007	ZZ	2RS	2RZ	N	NR	35	62	14	1.0	67.7	1.70	16.00	10.30	11000	16000	0.150										
6207	ZZ	2RS	2RZ	N	NR	35	72	17	1.1	78.6	1.70	25.60	15.30	10000	14000	0.290										
6307	ZZ	2RS	2RZ	N	NR	35	80	21	1.5	86.6	1.70	33.30	19.20	9300	13000	0.450										
6407	-	-	-	N	NR	35	100	25	1.5	106.5	2.46	55.50	29.40	8500	12000	0.950										
6008	ZZ	2RS	2RZ	N	NR	40	68	15	1.0	74.6	1.70	16.80	11.50	10000	15000	0.190										
6208	ZZ	2RS	2RZ	N	NR	40	80	18	1.1	86.6	1.70	29.10	17.90	8800	13000	0.370										
6308	ZZ	2RS	2RZ	N	NR	40	90	23	1.5	96.5	2.46	40.70	23.90	8500	12000	0.640										
6408	-	-	-	N	NR	40	110	27	2.0	116.6	2.46	63.70	34.60	7800	11000	1.250										
6009	ZZ	2RS	2RZ	N	NR	45	75	16	1.0	81.6	1.70	21.00	14.80	9100	13000	0.230										
6209	ZZ	2RS	2RZ	N	NR	45	85	19	1.1	91.6	1.70	31.70	20.50	8200	12000	0.420										
6309	ZZ	2RS	2RZ	N	NR	45	100	25	1.5	106.5	2.46	48.80	29.40	7800	11000	0.840										
6409	-	-	-	N	NR	45	120	29	2.0	129.7	2.82	77.20	45.20	7200	10000	1.550										
6010	ZZ	2RS	2RZ	N	NR	50	80	16	1.0	86.6	1.70	21.80	16.30	8300	12000	0.250										
6210	ZZ	2RS	2RZ	N	NR	50	90	20	1.1	96.5	2.46	35.10	23.20	7700	11000	0.460										
6310	ZZ	2RS	2RZ	N	NR	50	110	27	2.0	116.6	2.46	57.50	35.40	7200	10000	1.050										
6410	-	-	-	N	NR	50	130	31	2.1	139.7	2.82	83.10	49.40	6800	9700	1.900										
6011	ZZ	2RS	2RZ	N	NR	55	90	18	1.1	96.5	2.46	28.30	21.30	7800	11000	0.360										
6211	ZZ	2RS	2RZ	N	NR	55	100	21	1.5	106.5	2.46	43.40	29.20	7000	10000	0.610										
6311	ZZ	2RS	2RZ	N	NR	55	120	29	2.0	129.7	2.82	71.50	44.60	6700	10000	1.350										
6411	-	-	-	N	NR	55	140	33	2.1	149.7	2.82	100.70	62.40	6300	9100	2.300										

Most bearings in the 6000, 6200 and 6300 series up to 60 mm bore also can be made available in stainless steel (AISI 440C material).
Timken stainless steel bearing numbers are designated using the "H" suffix (e.g. 6203H-2RS).

Continued on next page.

DEEP GROOVE BALL BEARINGS

STANDARD 6000 SERIES

STANDARD 6000 SERIES – continued

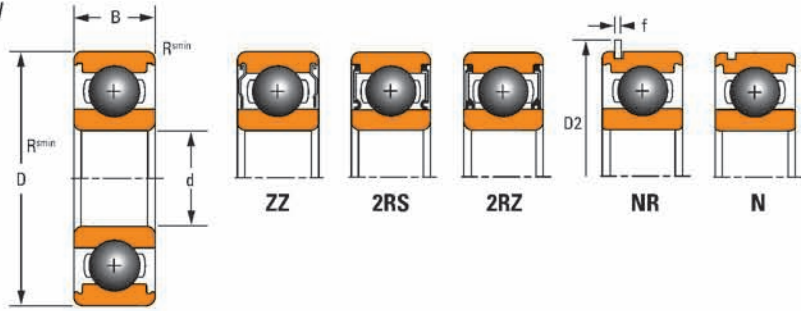

Continued from Table 10.

Description	Bearing No.					Boundary Dimensions						Load Ratings		Reference Speed		Weight
	Features					Bore	O.D.	Width	Radius			Dynamic	Static	Grease	Oil	
	Shields	Contact Seals	Non-Contact Seals	O.D. Groove	Snap Ring				$R_{s\ min}$	$D_{2\ max}$	f_{max}					
					d	D	B	$R_{s\ min}$	$D_{2\ max}$	f_{max}	C_r	C_{Dr}	RPM	RPM	kg	
6012	ZZ	2RS	2RZ	N	NR	60	95	18	1.1	101.6	2.46	29.40	23.20	7200	10000	0.390
6212	ZZ	2RS	2RZ	N	NR	60	110	22	1.5	116.6	2.46	47.70	32.90	6500	9300	0.780
6312	ZZ	2RS	2RZ	N	NR	60	130	31	2.1	139.7	2.82	81.80	52.00	6300	9100	1.700
6412	–	–	–	N	NR	60	150	35	2.1	159.7	2.82	109.00	70.10	6000	8600	2.730
6013	ZZ	2RS	2RZ	N	NR	65	100	18	1.1	106.5	2.46	30.50	24.80	6700	9700	0.430
6213	ZZ	2RS	2RZ	N	NR	65	120	23	1.5	129.7	2.82	57.20	40.00	6000	8600	0.990
6313	ZZ	2RS	2RZ	N	NR	65	140	33	2.1	149.7	2.82	92.60	59.70	6000	8600	2.100
6413	–	–	–	N	NR	65	160	37	2.1	169.7	2.82	118.00	78.60	5700	8200	3.300
6014	ZZ	2RS	2RZ	N	NR	70	110	20	1.1	116.6	2.46	38.10	30.40	6400	9300	0.570
6214	ZZ	2RS	2RZ	N	NR	70	125	24	1.5	134.7	2.82	60.80	44.00	5700	8300	1.100
6314	ZZ	2RS	2RZ	N	NR	70	150	35	2.1	159.7	2.82	104.00	68.00	5700	8200	2.500
6015	ZZ	2RS	2RZ	N	NR	75	115	20	1.1	121.6	2.46	39.50	33.20	6000	8700	0.600
6215	ZZ	2RS	2RZ	N	NR	75	130	25	1.5	139.7	2.82	66.10	48.20	5500	8000	1.200
6315	ZZ	2RS	2RZ	N	NR	75	160	37	2.1	169.7	2.82	113.40	76.90	5400	7800	3.000
6016	ZZ	2RS	2RZ	N	NR	80	125	22	1.1	134.7	2.82	47.50	39.70	5800	8400	0.820
6216	ZZ	2RS	2RZ	N	NR	80	140	26	2.0	149.7	2.82	71.50	53.00	5200	7500	1.400
6316	ZZ	2RS	2RZ	N	NR	80	170	39	2.1	182.9	3.10	122.90	86.50	5200	7500	3.600
6017	ZZ	2RS	2RZ	N	NR	85	130	22	1.1	139.7	2.82	49.50	42.80	5400	7900	0.850
6217	ZZ	2RS	2RZ	N	NR	85	150	28	2.0	159.7	2.82	83.20	61.90	5000	7200	1.800
6317	ZZ	2RS	2RZ	N	NR	85	180	41	3.0	192.9	3.10	132.70	96.50	5000	7200	4.250
6018	ZZ	2RS	2RZ	N	NR	90	140	24	1.5	149.7	2.82	58.00	49.60	5300	7600	1.120
6218	ZZ	2RS	2RZ	N	NR	90	160	30	2.0	169.7	2.82	96.00	71.50	4800	6900	2.150
6318	ZZ	2RS	2RZ	N	NR	90	190	43	3.0	202.9	3.10	142.60	107.20	4800	6900	4.900
6019	ZZ	2RS	2RZ	N	NR	95	145	24	1.5	154.7	2.82	57.70	50.00	5000	7300	1.180
6219	ZZ	2RS	2RZ	N	NR	95	170	32	2.1	182.9	3.10	108.70	81.70	4700	6700	2.600
6319	ZZ	2RS	2RZ	N	NR	95	200	45	3.0	212.9	3.10	152.70	118.40	4600	6600	5.750
6020	ZZ	2RS	2RZ	N	NR	100	150	24	1.5	159.7	2.82	60.10	54.20	4800	6900	1.250
6220	ZZ	2RS	2RZ	N	NR	100	180	34	2.1	192.9	3.10	122.00	92.70	4500	6500	3.200
6320	ZZ	2RS	2RZ	N	NR	100	215	47	3.0	227.8	3.50	173.20	140.90	4400	6200	6.980
6021	ZZ	2RS	2RZ	N	NR	105	160	26	2.0	169.7	2.82	69.20	61.20	4700	6800	1.600
6221	ZZ	2RS	2RZ	N	NR	105	190	36	2.1	202.9	3.10	133.00	104.00	4400	6300	3.710
6321	ZZ	2RS	2RZ	N	NR	105	225	49	3.0	214.3	3.50	183.70	153.10	4200	6000	8.110
6022	ZZ	2RS	2RZ	N	NR	110	170	28	2.0	182.9	3.10	81.90	72.80	4600	6600	1.930
6222	ZZ	2RS	2RZ	N	NR	110	200	38	2.1	212.9	3.10	144.00	117.00	4300	6100	4.440
6322	ZZ	2RS	2RZ	N	NR	110	240	50	3.0	252.0	3.50	205.40	179.40	3900	5500	9.480
6024	ZZ	2RS	2RZ	N	NR	120	180	28	2.0	192.9	3.10	84.90	79.20	4200	6100	2.030
6224	ZZ	2RS	2RZ	N	NR	120	215	40	2.1	227.8	3.10	155.30	131.10	4000	5700	5.160
6026	ZZ	2RS	2RZ	N	NR	130	200	33	2.0	212.9	3.10	105.00	96.80	4100	5900	3.150
6226	ZZ	2RS	2RZ	N	NR	130	230	40	3.0	242.0	3.50	166.80	146.30	3700	5200	5.850
6028	ZZ	2RS	2RZ	N	NR	140	210	33	2.0	222.8	3.10	110.00	108.60	3800	5500	3.500
6228	ZZ	2RS	2RZ	N	NR	140	250	42	3.0	262.0	3.50	165.00	125.00	3500	5000	7.450
6030	ZZ	2RS	2RZ	N	NR	150	225	35	2.1	237.0	3.50	125.00	126.00	3600	5200	4.900
6032	ZZ	2RS	2RZ	–	–	160	240	38	2.1	–	–	137.00	135.00	3500	5100	5.150

Most bearings in the 6000, 6200 and 6300 series up to 60 mm bore also can be made available in stainless steel (AISI 440C material). Timken stainless steel bearing numbers are designated using the "H" suffix (e.g. 6203H-2RS).

61000 THIN-SECTION SERIES

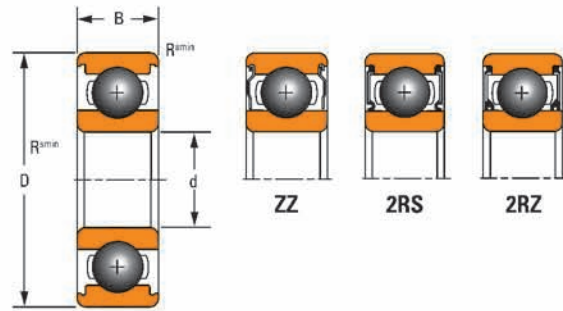

TABLE 11. 61000 THIN-SECTION SERIES

Description	Bearing No. Features			Boundary Dimensions				Load Ratings		Limiting Speed		Weight
	Shields	Contact Seals	Non-Contact Seals	Bore	O.D.	Width	Radius	Dynamic	Static	Grease	Oil	
				d	D	B	R _{s min}	C _r	C _{0r}	RPM	RPM	
61800	ZZ	2RS	2RZ	10	19	5	0.3	1.70	0.84	34000	40000	0.005
61900	ZZ	2RS	2RZ	10	22	6	0.3	2.70	1.30	31000	37000	0.009
61701	ZZ	2RS	-	12	18	4	0.2	0.93	0.53	13000	15000	0.003
61801	ZZ	2RS	2RZ	12	21	5	0.3	1.90	1.00	30000	36000	0.005
61901	ZZ	2RS	2RZ	12	24	6	0.3	2.90	1.50	28000	33000	0.010
61702	ZZ	2RS	-	15	21	4	0.2	0.94	0.58	11000	13000	0.003
61802	ZZ	2RS	2RZ	15	24	5	0.3	2.10	1.30	26000	31000	0.006
61902	ZZ	2RS	2RZ	15	28	7	0.3	4.30	2.30	24000	29000	0.015
61703	ZZ	2RS	-	17	23	4	0.2	1.00	0.66	9500	11000	0.004
61803	ZZ	2RS	2RZ	17	26	5	0.3	2.20	1.50	24000	29000	0.007
61903	ZZ	2RS	2RZ	17	30	7	0.3	4.60	2.60	22000	26000	0.016
61704	-	2RS	-	20	27	4	0.2	1.00	0.72	8500	10000	0.005
61804	ZZ	2RS	2RZ	20	32	7	0.3	4.00	2.50	21000	25000	0.016
61904	ZZ	2RS	2RZ	20	37	9	0.3	6.40	3.70	19000	22000	0.033
61705	-	2RS	-	25	32	4	0.2	1.10	0.84	7000	8000	0.006
61805	ZZ	2RS	2RZ	25	37	7	0.3	4.30	2.90	18000	21000	0.020
61905	ZZ	2RS	2RZ	25	42	9	0.3	7.00	4.60	16000	19000	0.039
61706	-	-	2RZ	30	37	4	0.2	1.10	0.95	5500	7000	0.007
61806	ZZ	2RS	2RZ	30	42	7	0.3	4.50	3.40	15000	18000	0.023
61906	ZZ	2RS	2RZ	30	47	9	0.3	7.20	5.00	14000	17000	0.044
61707	-	2RS	-	35	44	5	0.3	1.90	1.60	4900	6000	0.014
61807	ZZ	2RS	2RZ	35	47	7	0.3	4.70	3.80	13000	16000	0.027
61907	ZZ	2RS	2RZ	35	55	10	0.6	10.90	7.80	12000	14000	0.069
61708	-	2RS	-	40	50	6	0.3	2.50	2.20	4300	5000	0.021
61808	ZZ	2RS	2RZ	40	52	7	0.3	4.90	4.20	12000	14000	0.029
61908	ZZ	2RS	2RZ	40	62	12	0.6	13.70	9.90	11000	13000	0.101
61709	-	2RS	-	45	55	6	0.3	2.60	2.40	3900	4600	0.023
61809	ZZ	2RS	2RZ	45	58	7	0.3	6.20	5.40	11000	13000	0.034
61909	ZZ	2RS	2RZ	45	68	12	0.6	14.10	10.90	10000	11000	0.123
61710	-	2RS	-	50	62	6	0.3	2.70	2.70	3500	4100	0.034
61810	ZZ	2RS	2RZ	50	65	7	0.3	6.20	5.80	9500	11000	0.047
61910	ZZ	2RS	2RZ	50	72	12	0.6	14.50	11.70	9000	11000	0.123
61811	ZZ	2RS	2RZ	55	72	9	0.3	8.80	8.10	8600	10000	0.075
61911	ZZ	2RS	2RZ	55	80	13	1.0	16.60	14.10	8100	9600	0.168
61812	ZZ	2RS	2RZ	60	78	10	0.3	11.50	10.60	7900	9400	0.094
61912	ZZ	2RS	2RZ	60	85	13	1.0	20.20	17.30	7500	8900	0.180
61813	ZZ	2RS	-	65	85	10	0.6	11.90	11.50	7300	8600	0.118
61913	ZZ	2RS	-	65	90	13	1.0	17.30	16.00	7000	8300	0.198

The bearing sizes listed above also can be made available in stainless steel (AISI 440C material). Timken stainless steel bearing numbers are designated using the "H" suffix (e.g. 61807H).

16000 NARROW SERIES

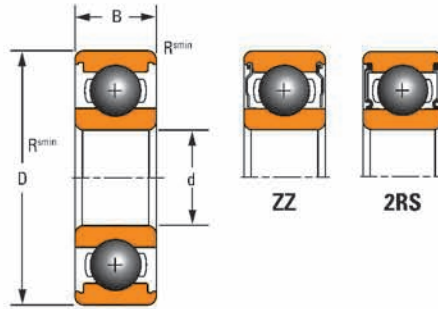

TABLE 12. 16000 NARROW SERIES

Description	Bearing No.		Boundary Dimensions				Load Ratings		Limiting Speed		Weight
	Features		Bore	O.D.	Width	Radius	Dynamic	Static	Grease	Oil	
	Shields	Contact Seals	d	D	B	R_{s_min}	C_r	C_{0r}	RPM	RPM	
			mm	mm	mm	mm	kN	kN	RPM	RPM	kg
16100	ZZ	–	10	28	8	0.3	4.60	2.00	25000	37000	0.022
16101	ZZ	2RS	12	30	8	0.3	5.10	2.40	22000	33000	0.024
16002	ZZ	–	15	32	8	0.3	5.60	2.80	19000	27000	0.027
16003	ZZ	–	17	35	8	0.3	6.00	3.30	17000	24000	0.030
16004	–	–	20	42	8	0.3	7.90	4.50	13000	20000	0.050
16005	ZZ	–	25	47	8	0.3	8.90	5.60	11000	16000	0.060
16006	–	–	30	55	9	0.3	11.20	7.40	10000	14000	0.080
16007	–	–	35	62	9	0.3	12.20	8.80	8400	12000	0.100
16008	–	–	40	68	9	0.3	12.60	9.70	7400	11000	0.130
16009	–	–	45	75	10	0.6	15.50	12.30	6900	10000	0.170
16010	–	–	50	80	10	0.6	16.00	13.20	6300	9100	0.180
16011	–	–	55	90	11	0.6	19.40	16.30	5800	8500	0.260
16012	–	–	60	95	11	0.6	19.90	17.60	5400	7800	0.220
16013	–	–	65	100	11	0.6	17.20	15.90	5000	7300	0.290
16014	–	–	70	110	13	0.6	26.80	23.60	5000	7200	0.430
16015	–	–	75	115	13	0.6	27.50	25.30	4600	6700	0.450
16016	–	–	80	125	14	0.6	31.70	29.70	4400	6400	0.590
16017	–	–	85	130	14	0.6	32.60	31.60	4200	6100	0.570
16018	–	–	90	140	16	1.0	39.90	37.00	4200	6100	0.670
16019	–	–	95	145	16	1.0	42.70	41.90	3900	5700	0.710
16020	–	–	100	150	16	1.0	43.80	44.30	3800	5400	0.740
16021	–	–	105	160	18	1.0	51.80	50.60	3800	5400	1.000
16022	–	–	110	170	19	1.0	57.40	56.70	3600	5300	1.300
16024	–	–	120	180	19	1.0	58.80	60.40	3300	4800	1.400
16026	–	–	130	200	22	1.1	79.70	79.20	3200	4700	1.900
16028	–	–	140	210	22	1.1	82.10	85.00	3000	4400	2.000
16030	–	–	150	225	24	1.1	91.90	98.50	2900	4200	2.600
16032	–	–	160	240	25	1.5	99.00	108.00	2800	4000	4.200

62000-63000 WIDE SERIES

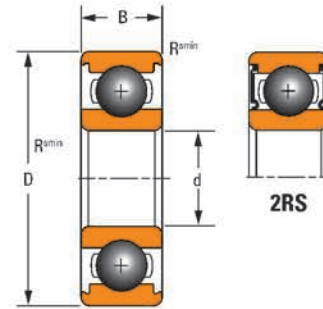

TABLE 13. 62000-63000 WIDE SERIES

Bearing No.		Boundary Dimensions				Load Ratings		Limiting Speed		Weight
Description	Contact Seals	Bore	O.D.	Width	Radius	Dynamic	Static	Grease	Oil	
		d	D	B	R _{s min}	C _r	C _{0r}	RPM	RPM	
		mm	mm	mm	mm	kN	kN	RPM	RPM	kg
62200	2RS	10	30	14	0.6	6.00	2.60	29000	42000	0.040
62300	2RS	10	35	17	0.6	8.10	3.40	26000	38000	0.070
63000	2RS	10	26	12	0.3	4.60	2.00	33000	49000	0.030
62201	2RS	12	32	14	0.6	6.90	3.10	26000	37000	0.050
62301	2RS	12	37	17	1.0	9.70	4.20	23000	34000	0.080
63001	2RS	12	28	12	0.3	5.10	2.40	29000	43000	0.030
62202	2RS	15	35	14	0.6	7.70	3.80	22000	32000	0.050
62302	2RS	15	42	17	1.0	11.30	5.40	19000	28000	0.100
63002	2RS	15	32	13	0.3	5.60	2.80	25000	37000	0.040
62203	2RS	17	40	16	0.6	9.60	4.80	20000	30000	0.080
62303	2RS	17	47	19	1.0	13.60	6.60	18000	26000	0.140
63003	2RS	17	35	14	0.3	6.00	3.30	23000	34000	0.050
62204	2RS	20	47	18	1.0	12.80	6.60	18000	26000	0.120
62304	2RS	20	52	21	1.1	15.90	7.90	17000	24000	0.140
63004	2RS	20	42	16	0.6	9.40	5.00	20000	30000	0.090
62205	2RS	25	52	18	1.0	14.00	7.90	15000	22000	0.150
62305	2RS	25	62	24	1.1	23.60	12.10	14000	21000	0.300
63005	2RS	25	47	16	0.6	10.10	5.80	17000	25000	0.100
62206	2RS	30	62	20	1.0	19.50	11.30	13000	19000	0.230
62306	2RS	30	72	27	1.1	28.20	15.80	13000	18000	0.470
63006	2RS	30	55	19	1.0	13.20	8.30	15000	23000	0.150
62207	2RS	35	72	23	1.1	25.70	15.30	12000	17000	0.370
62307	2RS	35	80	31	1.5	33.30	19.20	12000	17000	0.620
63007	2RS	35	62	20	1.0	16.00	10.30	14000	20000	0.200
62208	2RS	40	80	23	1.1	29.10	17.90	10000	15000	0.440
62308	2RS	40	90	33	1.5	40.70	23.90	11000	15000	0.850
63008	2RS	40	68	21	1.0	16.80	11.60	12000	18000	0.240
62209	2RS	45	85	23	1.1	32.70	20.50	9300	13000	0.460
62309	2RS	45	100	36	1.5	37.20	26.30	9800	14000	1.100
62210	2RS	50	90	23	1.1	35.10	23.20	8500	12000	0.470
62310	2RS	50	110	40	2.0	47.60	35.70	9200	13000	1.500
62211	2RS	55	100	25	1.5	43.40	29.20	7800	11000	0.680
62311	2RS	55	120	43	2.0	71.50	45.00	8600	12000	2.000
62212	2RS	60	110	28	1.5	47.50	32.50	7500	11000	1.000
62312	2RS	60	130	46	2.1	81.80	51.90	8100	12000	2.500
62213	2RS	65	120	31	1.5	55.90	40.50	7200	10000	1.300
62214	2RS	70	125	31	1.5	60.50	45.50	6700	9700	1.400

EXTRA-SMALL 600 SERIES

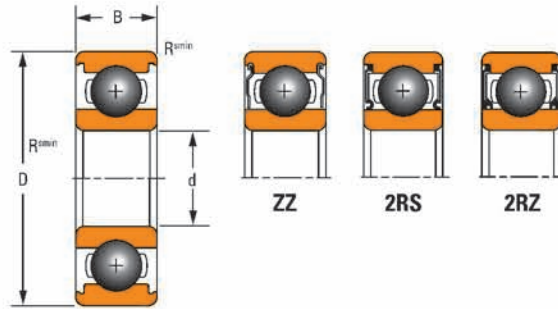

TABLE 14. EXTRA-SMALL 600 SERIES

Description	Bearing No.			Boundary Dimensions				Load Ratings		Limiting Speed		Weight
	Features			Bore	O.D.	Width	Radius	Dynamic	Static	Grease	Oil	
	Shields	Contact Seals	Non-Contact Seals									
				d	D	B	$R_{s\ min}$	kN	kN	RPM	RPM	kg
618/3	ZZ	2RS	2RZ	3	7	2	0.10	0.31	0.11	74000	88000	0.0003
619/3	ZZ	2RS	-	3	8	3	0.15	0.56	0.18	70000	82000	0.0006
603	ZZ	-	-	3	9	3	0.15	0.57	0.19	66000	78000	0.0009
623	ZZ	2RS	2RZ	3	10	4	0.15	0.63	0.22	66000	78000	0.0016
633	ZZ	2RS	2RZ	3	13	5	0.20	1.30	0.49	51000	60000	0.0030
618/4	ZZ	2RS	2RZ	4	9	2.5	0.10	0.64	0.23	63000	75000	0.0006
619/4	ZZ	2RS	2RZ	4	11	4	0.15	1.00	0.35	57000	67000	0.0017
604	ZZ	2RS	2RZ	4	12	4	0.20	1.00	0.35	57000	67000	0.0020
624	ZZ	2RS	2RZ	4	13	5	0.20	1.30	0.49	51000	60000	0.0027
634	ZZ	2RS	2RZ	4	16	5	0.30	1.30	0.52	46000	54000	0.0050
618/5	ZZ	2RS	2RZ	5	11	3	0.15	0.72	0.28	54000	64000	0.0012
619/5	ZZ	2RS	2RZ	5	13	4	0.20	1.10	0.43	50000	59000	0.0021
605	ZZ	2RS	2RZ	5	14	5	0.20	1.30	0.51	48000	56000	0.0030
625	ZZ	2RS	2RZ	5	16	5	0.30	1.70	0.67	44000	52000	0.0040
635	ZZ	2RS	2RZ	5	19	6	0.30	2.30	0.89	38000	45000	0.0080
618/6	ZZ	2RS	2RZ	6	13	3.5	0.15	1.10	0.44	48000	56000	0.0019
619/6	ZZ	2RS	2RZ	6	15	5	0.20	1.30	0.52	46000	54000	0.0040
606	ZZ	2RS	2RZ	6	17	6	0.30	2.30	0.84	42000	49000	0.0050
626	ZZ	2RS	2RZ	6	19	6	0.30	2.30	0.89	38000	45000	0.0070
636	ZZ	2RS	2RZ	6	22	7	0.30	3.30	1.40	33000	39000	0.0120
618/7	ZZ	2RS	2RZ	7	14	3.5	0.15	1.20	0.51	44000	52000	0.0020
619/7	ZZ	2RS	2RZ	7	17	5	0.30	1.60	0.72	40000	47000	0.0050
607	ZZ	2RS	2RZ	7	19	6	0.30	2.30	0.89	38000	45000	0.0070
627	ZZ	2RS	2RZ	7	22	7	0.30	3.30	1.40	33000	39000	0.0120
637	ZZ	2RS	2RZ	7	26	9	0.30	4.60	2.00	28000	33000	0.0220
618/8	ZZ	2RS	2RZ	8	16	4	0.20	1.30	0.59	40000	47000	0.0032
619/8	ZZ	2RS	2RZ	8	19	6	0.30	2.20	0.91	37000	44000	0.0060
608	ZZ	2RS	2RZ	8	22	7	0.30	3.30	1.40	33000	39000	0.0110
628	ZZ	2RS	2RZ	8	24	8	0.30	3.30	1.40	31000	37000	0.0170
638	ZZ	2RS	2RZ	8	28	9	0.30	4.60	2.00	28000	33000	0.0270
618/9	ZZ	2RS	2RZ	9	17	4	0.20	1.30	0.66	37000	44000	0.0034
619/9	ZZ	2RS	2RZ	9	20	6	0.30	2.50	1.10	35000	42000	0.0070
609	ZZ	2RS	2RZ	9	24	7	0.30	3.40	1.40	30000	36000	0.0130
629	ZZ	2RS	2RZ	9	26	8	0.30	4.60	2.00	28000	33000	0.0180
639	ZZ	2RS	2RZ	9	30	10	0.60	5.10	2.40	25000	30000	0.0330

The bearing sizes listed above also can be made available in stainless steel (AISI 440C material). Timken stainless steel bearing numbers are designated using the "H" suffix (e.g. 627H-2RS).

TIMKEN

The Timken team applies their know-how to improve the reliability and performance of machinery in diverse markets worldwide. The company designs, makes and markets high-performance mechanical components, including bearings, belts, chain, gears and related mechanical power transmission products and services.

Stronger. **Commitment.** Stronger. **Value.** Stronger. **Worldwide.** Stronger. **Together.** | Stronger. **By Design.**

www.timken.com