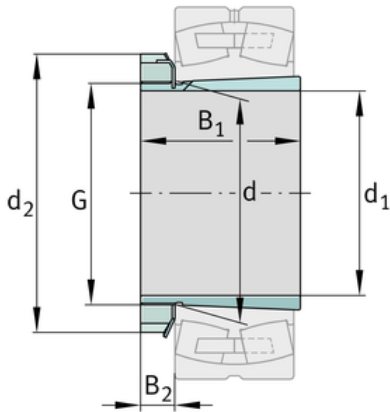
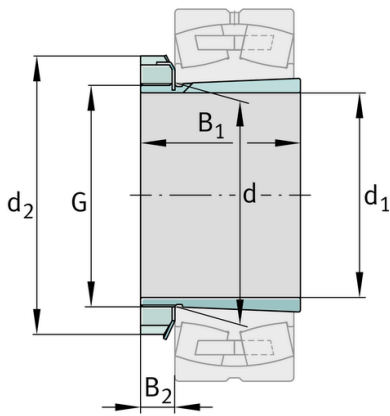
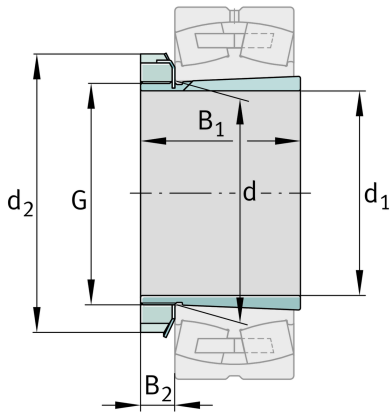

**FAG****H213****Adapter sleeve**Schaeffler ID:
0167306230000Adapter sleeve H, accessory rolling
bearing, complete, mechanical, FP

Technical information

**Dimensions**

d	65 mm	Bore diameter bearing
d ₂	85 mm	Outside diameter nut
B ₂	13,5 mm	Width nut and lock
	0,4 kg	Weight

Main Dimensions & Performance Data

d ₁	60 mm	bore diameter
G	M65x2	Thread
B ₁	40 mm	sleeve length

Additional information

	KM13	Locknut
	MB13	Fuse
	1:12	Taper

