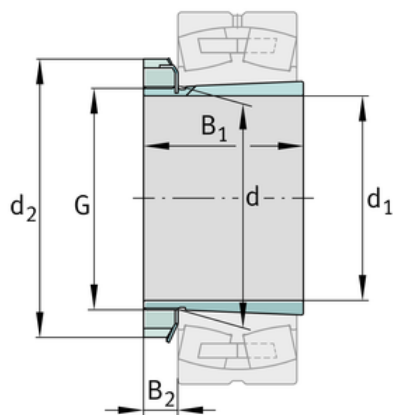
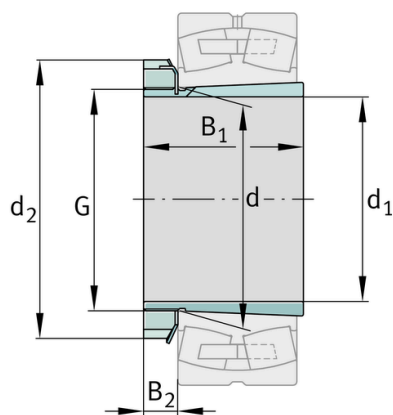
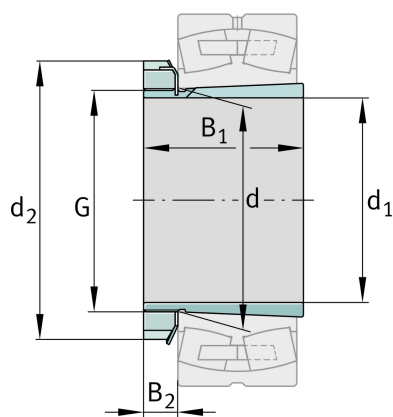

**FAG****H211****Adapter sleeve**Schaeffler ID:
0167306070000Adapter sleeve H, accessory rolling
bearing, complete, mechanical, FP

Technical information

**Dimensions**

d	55 mm	Bore diameter bearing
d ₂	75 mm	Outside diameter nut
B ₂	12,5 mm	Width nut and lock
	0,16 kg	Weight

Main Dimensions & Performance Data

d ₁	50 mm	bore diameter
G	M55x2	Thread
B ₁	37 mm	sleeve length

Additional information

	KM11	Locknut
	MB11	Fuse
	1:12	Taper

