



SL045008-D-PP

Cylindrical roller bearing

Schaeffler ID:
 \${ctx.productData.sapMaterialNumber}

Cylindrical roller bearing SL04...-D-PP, full complement roller set, two-row, locating bearing, central rib on outer ring, 3 ribs on inner ring, type SL04

Technical information

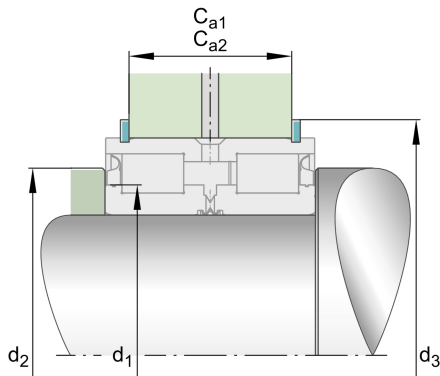

Main Dimensions & Performance Data

d	40 mm	Bore diameter
D	68 mm	Outside diameter
B	38 mm	Width
C_r	80.000 N	Basic dynamic load rating, radial
C_{0r}	111.000 N	Basic static load rating, radial
C_{ur}	16.300 N	Fatigue load limit, radial
$n_{G \text{ Grease}}$	3.150 1/min	Limiting speed for grease lubrication
	0,56 kg	Weight

Dimensions

C	37 mm	Width, outer ring
C_1	32,2 mm	Distance ring grooves
D_1	65,8 mm	Diameter of groove
m	2,7 mm	Width of groove
r_{\min}	0,6 mm	Minimum chamfer dimension
t	0,8 mm	Chamfer width
X	28,5 mm	Distance between rolling elements

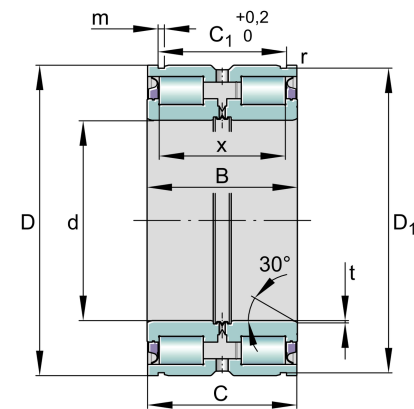

Mounting dimensions

C_{a1}	28 mm	Mounting dim for snap ring WER (not included in delivery) Tolerance: 0/-0,2
C_{a2}	27 mm	Mounting dim for retaining ring to DIN 471 (not incl. In delivery) Tol: 0/-0,2
d_1	51,5 mm	Rib diameter inner ring
d_2	55 mm	Sealing diameter (rib)
d_3	75 mm	Outside diameter of snap ring WRE
$d_{1\min}$	46,5 mm	Minimum diameter shaft shoulder
$r_{a\max}$	0,6 mm	Maximum recess radius
	30 °	Chamfer angle
	-0,2 mm	Lower distance snap ring tolerance
	-0,2 mm	Lower distance retaining ring tolerance
	0,2 mm	Upper distance ring groove tolerance

Temperature range

T_{\min}	-30 °C	Operating temperature min.
T_{\max}	80 °C	Operating temperature max.