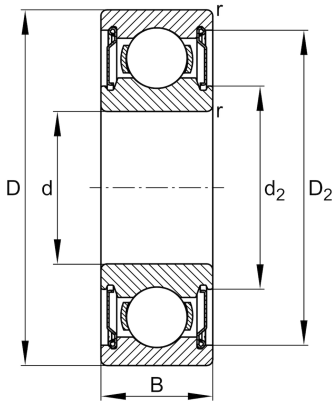
**FAG****6305-H-2Z**

Deep groove ball bearing

Schaeffler ID:
0938686000000

Deep groove ball bearing 63..-H-2Z, single row, H-Series, shields, steel sheet metal cage

Technical information

**Temperature range**

T_{min}	-20 °C	Operating temperature min.
T_{max}	120 °C	Operating temperature max.
	0,24 kg	Weight

Main Dimensions & Performance Data

d	25 mm	Bore diameter
D	62 mm	Outside diameter
B	17 mm	Width
C_r	22.410 N	Basic dynamic load rating, radial
C_{0r}	11.510 N	Basic static load rating, radial
C_{ur}	710 N	Fatigue load limit, radial
n_G	13.700 1/min	Limiting speed
n_{gr}	12.300 1/min	Reference speed

Dimensions

r_{min}	1,1 mm	Minimum chamfer dimension
D_2	53,2 mm	Caliber diameter outer ring
d_2	34,2 mm	Caliber diameter inner ring

Mounting dimensions

$d_{a min}$	32 mm	Minimum diameter shaft shoulder
$D_{a max}$	55 mm	Maximum diameter of housing shoulder
$r_{a max}$	1,1 mm	Maximum fillet radius

Calculation factors

f_0	12,4	Calculation factor
-------	------	--------------------

