

**FAG****UCF215**

Flanged housing unit

Schaeffler ID:
0812174550000

Flanged housing unit UCF

Technical information

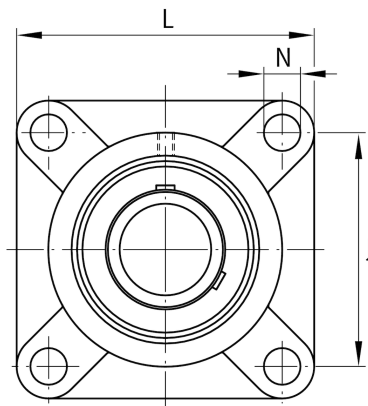
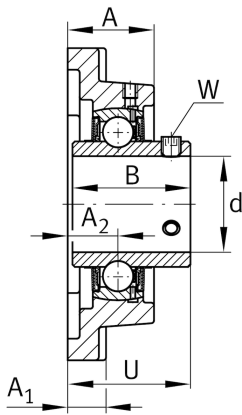
**Dimensions**

A	56 mm	Height housing
A ₁	24 mm	Thickness of flange
A ₂	34 mm	Distance raceway
B	78,5 mm	Width
Q	M6	Connection thread lubrication
	6,7 kg	Weight

Main Dimensions & Performance Data

d	75 mm	Bore diameter
L	200 mm	Flange width
U	78,5 mm	Total height unit
C _r	66.000 N	Basic dynamic load rating, radial
C _{0r}	44.500 N	Basic static load rating, radial
C _{ur}	1.880 N	Fatigue load limit, radial

Mounting dimensions

J	159 mm	Distance fixing bore
N	19 mm	Fixing bore
N ₁	159 mm	Distance fixing bore
n	4	Number of screwing holes

Additional information

	1	Number of housings
	F215	Housing
	UC215	Bearing designation