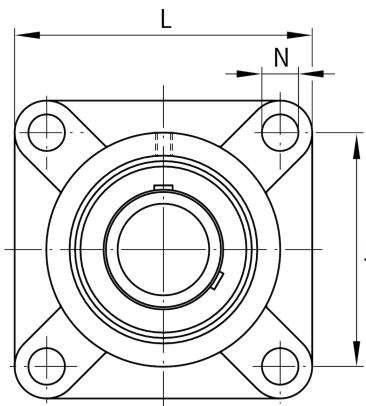
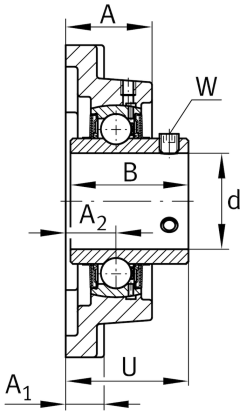
**FAG****UCF214**

Flanged housing unit

Schaeffler ID:
0812171290000

Flanged housing unit UCF

Technical information

**Dimensions**

A	54 mm	Height housing
A ₁	24 mm	Thickness of flange
A ₂	31 mm	Distance raceway
B	75,4 mm	Width
Q	M6	Connection thread lubrication
	5,92 kg	Weight

Main Dimensions & Performance Data

d	70 mm	Bore diameter
L	193 mm	Flange width
U	75,4 mm	Total height unit
C _r	66.000 N	Basic dynamic load rating, radial
C _{0r}	44.000 N	Basic static load rating, radial
C _{ur}	1.870 N	Fatigue load limit, radial

Mounting dimensions

J	152 mm	Distance fixing bore
N	19 mm	Fixing bore
N ₁	152 mm	Distance fixing bore
n	4	Number of screwing holes

Additional information

	1	Number of housings
	F214	Housing
	UC214	Bearing designation