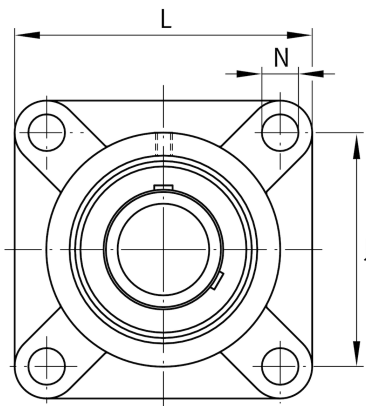
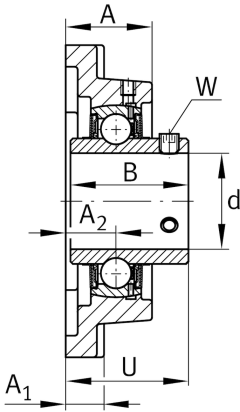
**FAG****UCF210**

Flanged housing unit

Schaeffler ID:
0808221690000

Flanged housing unit UCF

Technical information

**Dimensions**

A	40 mm	Height housing
A ₁	18 mm	Thickness of flange
A ₂	22 mm	Distance raceway
B	51,6 mm	Width
Q	M6	Connection thread lubrication
	2,601 kg	Weight

Main Dimensions & Performance Data

d	50 mm	Bore diameter
L	143 mm	Flange width
U	54,6 mm	Total height unit
C _r	35.000 N	Basic dynamic load rating, radial
C _{0r}	23.200 N	Basic static load rating, radial
C _{ur}	990 N	Fatigue load limit, radial

Mounting dimensions

J	111 mm	Distance fixing bore
N	16 mm	Fixing bore
N ₁	111 mm	Distance fixing bore
n	4	Number of screwing holes

Additional information

	1	Number of housings
	F210	Housing
	UC210	Bearing designation