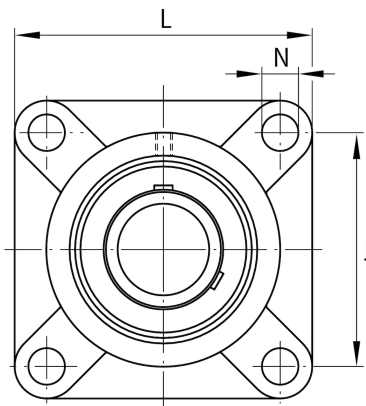
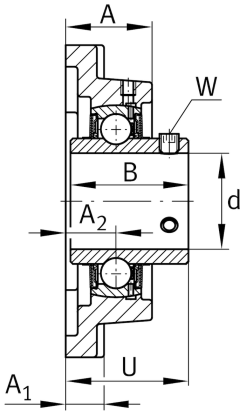
**FAG****UCF207**

Flanged housing unit

Schaeffler ID:  
0808216930000

Flanged housing unit UCF

## Technical information

**Dimensions**

A	34 mm	Height housing
A <sub>1</sub>	16 mm	Thickness of flange
A <sub>2</sub>	19 mm	Distance raceway
B	42,9 mm	Width
Q	M6	Connection thread lubrication
	1,524 kg	Weight

**Main Dimensions & Performance Data**

d	35 mm	Bore diameter
L	117 mm	Flange width
U	44,4 mm	Total height unit
C <sub>r</sub>	25.500 N	Basic dynamic load rating, radial
C <sub>0r</sub>	15.300 N	Basic static load rating, radial
C <sub>ur</sub>	650 N	Fatigue load limit, radial

**Mounting dimensions**

J	92 mm	Distance fixing bore
N	14 mm	Fixing bore
N <sub>1</sub>	92 mm	Distance fixing bore
n	4	Number of screwing holes

**Additional information**

	1	Number of housings
	F207	Housing
	UC207	Bearing designation