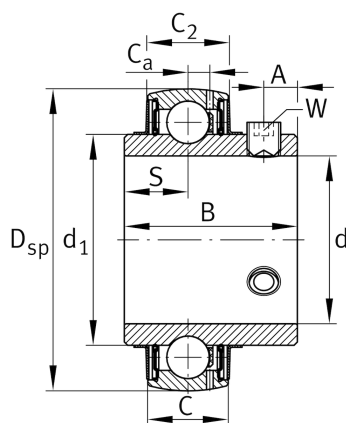

**FAG****UC210**

Radial insert ball bearing

Schaeffler ID:
0693735400000Radial insert ball bearings UC, spherical
outer ring, location by grub screws, RSR
seals on both sides

Technical information

**Main Dimensions & Performance Data**

d	50 mm	Bore diameter
D _{SP}	90 mm	Outside diameter
B	51,6 mm	Width
n _{G Grease}	9.000 1/min	Limiting speed for grease lubrication
C _r	37.500 N	Basic dynamic load rating, radial
C _{0r}	23.200 N	Basic static load rating, radial
C _{ur}	1.210 N	Fatigue load limit, radial
	0,803 kg	Weight

Dimensions

C	24 mm	Width, outer ring
C ₂	24,6 mm	Sealing total width
S	19 mm	Distance raceway
d ₁	62,84 mm	Rib diameter inner ring
C _a	6,5 mm	Distance to lubrication hole
A	10 mm	Distance thread
W	5 mm	Width of flats

Calculation factors

f ₀	14,4	Calculation factor
----------------	------	--------------------