

PASE20-XL-N

Plummer block housing unit

Schaeffler ID:
0096411810000

Plummer block housing units PASE, cast iron housing, radial insert ball bearing with eccentric locking collar, P seals

X-life

Technical information

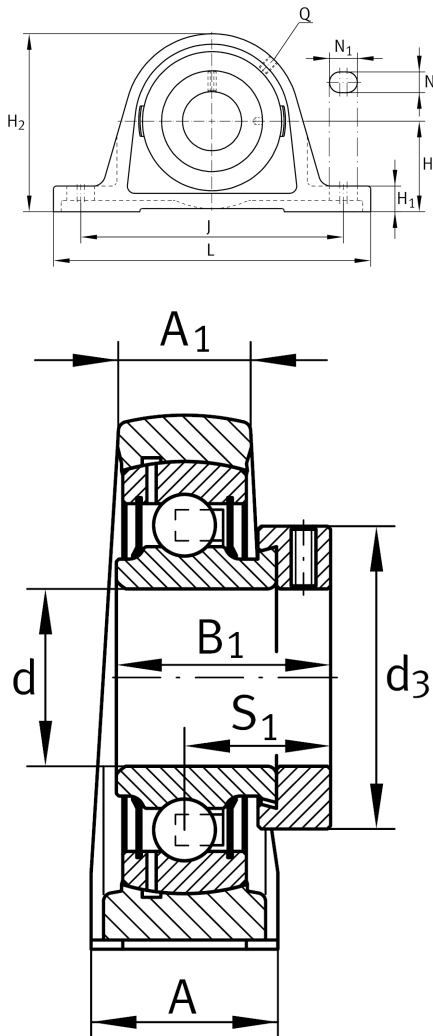

Dimensions

H	33,3 mm	Distance shaft axis
A	32 mm	Width (base)
A ₁	19 mm	Width (head)
H ₁	14,5 mm	Height (base)
B ₁	31 mm	Locking collar total width
S ₁	23,5 mm	Distance of raceway to locking collar
Q	M6	Connection thread lubrication
	0,6 kg	Weight

Main Dimensions & Performance Data

d	20 mm	Bore diameter
L	130 mm	Length total
H ₂	64 mm	Height

Mounting dimensions

J	97,5 mm	Distance fixing bore
N	11 mm	Width (slot)
N ₁	19 mm	Length (slot)

Additional information

ASE04	Housing
GRAE20-XL-NPP-B	Bearing designation
KASK04	Protecting cap