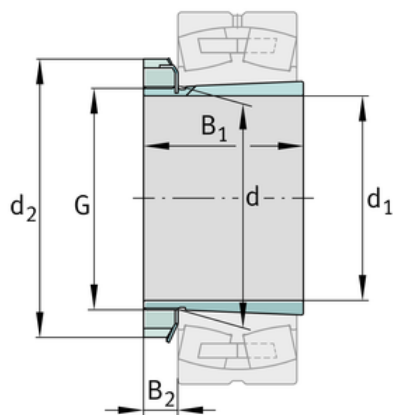
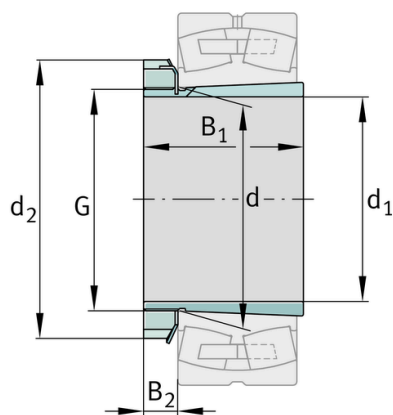
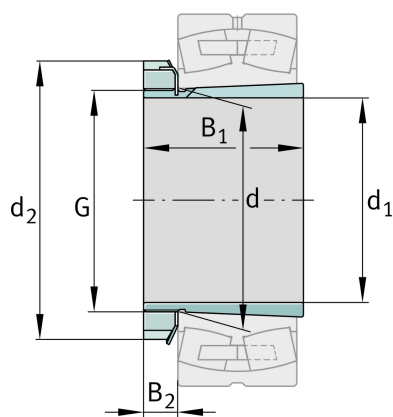

**FAG****H319**

Adapter sleeve

Schaeffler ID:
0167313010000Adapter sleeve H, accessory rolling
bearing, complete, mechanical, FP

Technical information

**Dimensions**

d	95 mm	Bore diameter bearing
d ₂	125 mm	Outside diameter nut
B ₂	18,75 mm	Width nut and lock
	1,637 kg	Weight

Main Dimensions & Performance Data

d ₁	85 mm	bore diameter
G	M95x2	Thread
B ₁	68 mm	sleeve length

Additional information

	KM19	Locknut
	MB19	Fuse
	1:12	Taper

