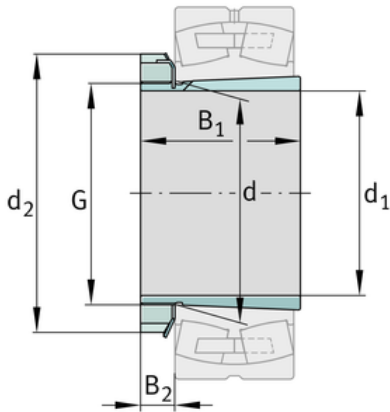
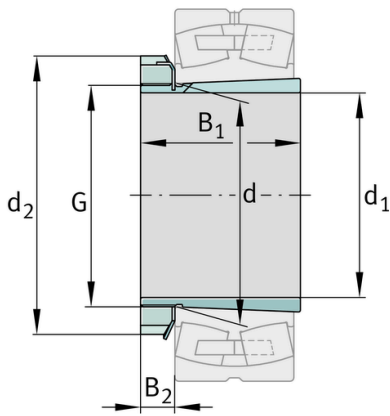
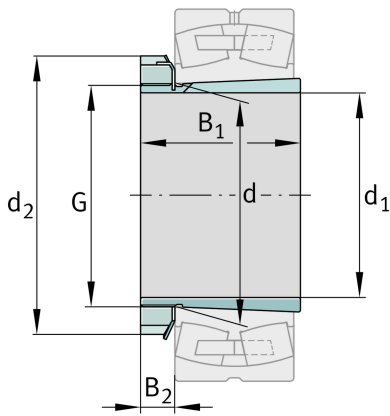

**FAG****H315**

Adapter sleeve

Schaeffler ID:
0167312470000Adapter sleeve H, accessory rolling
bearing, complete, mechanical, FP

Technical information

**Dimensions**

d	75 mm	Bore diameter bearing
d ₂	98 mm	Outside diameter nut
B ₂	14,5 mm	Width nut and lock
	0,8 kg	Weight

Main Dimensions & Performance Data

d ₁	65 mm	bore diameter
G	M75x2	Thread
B ₁	55 mm	sleeve length

Additional information

	KM15	Locknut
	MB15	Fuse
	1:12	Taper

