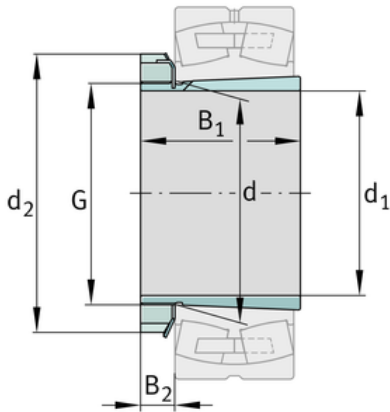
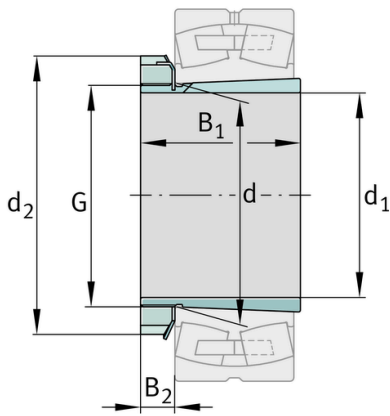
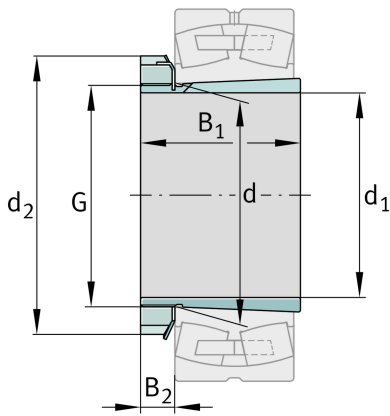

**FAG****H3134**

Adapter sleeve

Schaeffler ID:
0167311900000Adapter sleeve H, accessory rolling
bearing, complete, mechanical, FP

Technical information

**Dimensions**

d	170 mm	Bore diameter bearing
d ₂	220 mm	Outside diameter nut
B ₂	28,5 mm	Width nut and lock
	8,68 kg	Weight

Main Dimensions & Performance Data

d ₁	150 mm	bore diameter
G	M170x3	Thread
B ₁	122 mm	sleeve length

Additional information

	KM34	Locknut
	MB34	Fuse
	1:12	Taper

