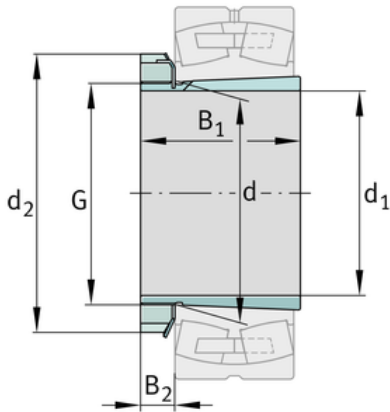
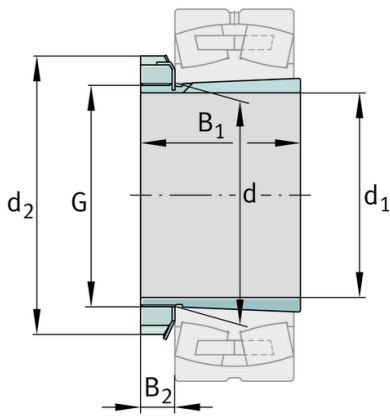
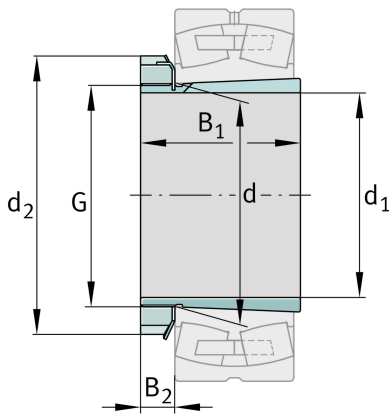
**FAG****H2332**

Adapter sleeve

Schaeffler ID:
0167308950000Adapter sleeve H, accessory rolling
bearing, complete, mechanical, FP

Technical information

**Dimensions**

d	160 mm	Bore diameter bearing
d ₂	210 mm	Outside diameter nut
B ₂	27,5 mm	Width nut and lock
	9,4 kg	Weight

Main Dimensions & Performance Data

d ₁	140 mm	bore diameter
G	M160x3	Thread
B ₁	147 mm	sleeve length

Additional information

	KM32	Locknut
	MB32	Fuse
	1:12	Taper

