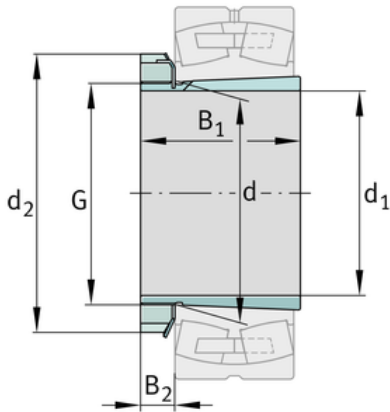
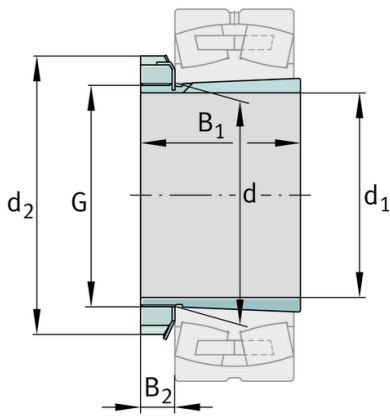
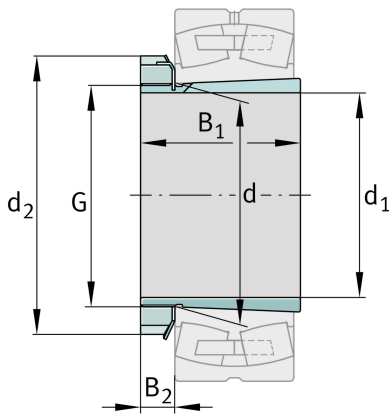
**FAG****H2317**

Adapter sleeve

Schaeffler ID:
0167308010000Adapter sleeve H, accessory rolling
bearing, complete, mechanical, FP

Technical information

**Dimensions**

d	85 mm	Bore diameter bearing
d ₂	110 mm	Outside diameter nut
B ₂	17,75 mm	Width nut and lock
	1,541 kg	Weight

Main Dimensions & Performance Data

d ₁	75 mm	bore diameter
G	M85x2	Thread
B ₁	82 mm	sleeve length

Additional information

	KM17	Locknut
	MB17	Fuse
	1:12	Taper

