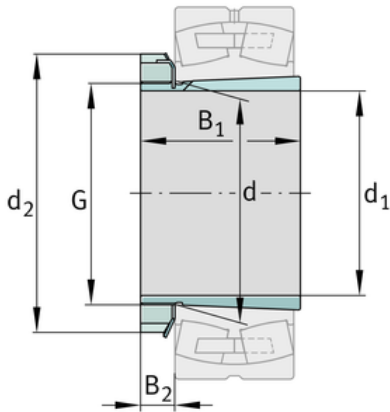
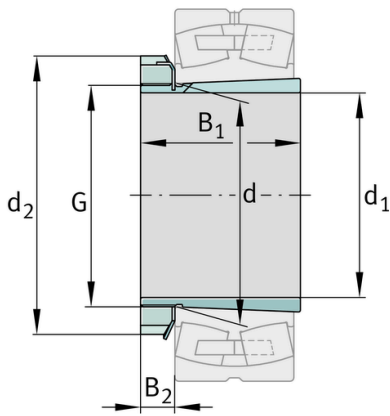
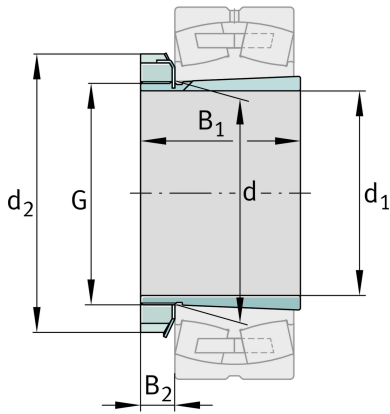

**FAG****H2316**

## Adapter sleeve

Schaeffler ID:  
0167307980000Adapter sleeve H, accessory rolling  
bearing, complete, mechanical, FP

## Technical information

**Dimensions**

d	80 mm	Bore diameter bearing
d <sub>2</sub>	105 mm	Outside diameter nut
B <sub>2</sub>	16,75 mm	Width nut and lock
	1,3 kg	Weight

**Main Dimensions & Performance Data**

d <sub>1</sub>	70 mm	bore diameter
G	M80x2	Thread
B <sub>1</sub>	78 mm	sleeve length

**Additional information**

	KM16	Locknut
	MB16	Fuse
	1:12	Taper

