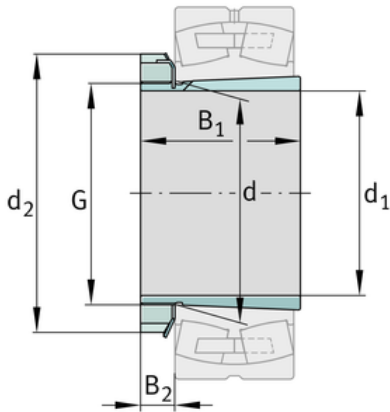
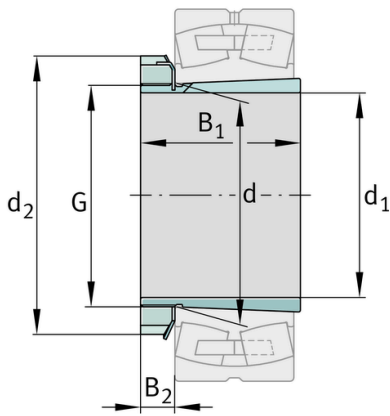
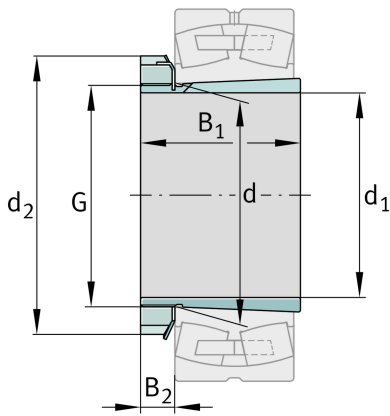

**FAG****H2313**

## Adapter sleeve

Schaeffler ID:  
0167307710000Adapter sleeve H, accessory rolling  
bearing, complete, mechanical, FP

## Technical information

**Dimensions**

d	65 mm	Bore diameter bearing
d <sub>2</sub>	85 mm	Outside diameter nut
B <sub>2</sub>	13,5 mm	Width nut and lock
	0,55 kg	Weight

**Main Dimensions & Performance Data**

d <sub>1</sub>	60 mm	bore diameter
G	M65x2	Thread
B <sub>1</sub>	65 mm	sleeve length

**Additional information**

	KM13	Locknut
	MB13	Fuse
	1:12	Taper

