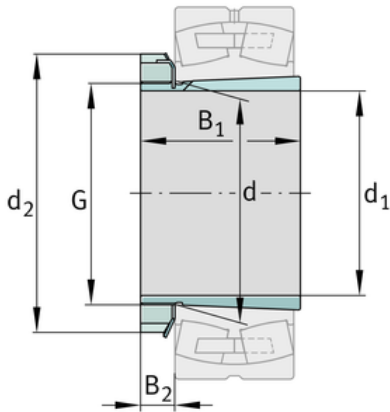
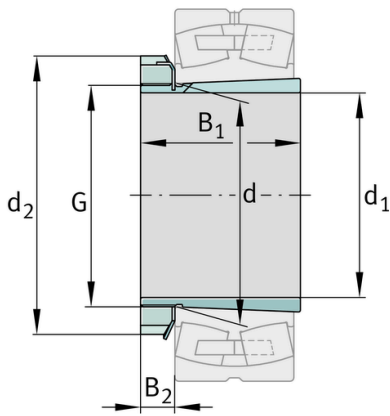
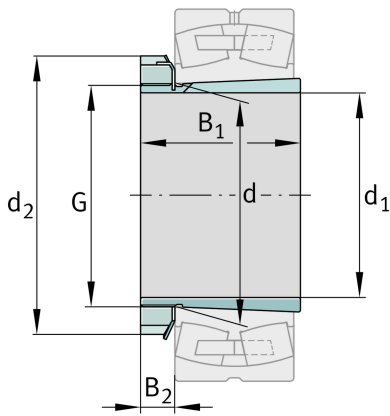

**FAG****H2312**

Adapter sleeve

Schaeffler ID:
0167307630000Adapter sleeve H, accessory rolling
bearing, complete, mechanical, FP

Technical information

**Dimensions**

d	60 mm	Bore diameter bearing
d ₂	80 mm	Outside diameter nut
B ₂	12,5 mm	Width nut and lock
	0,52 kg	Weight

Main Dimensions & Performance Data

d ₁	55 mm	bore diameter
G	M60x2	Thread
B ₁	62 mm	sleeve length

Additional information

	KM12	Locknut
	MB12	Fuse
	1:12	Taper

