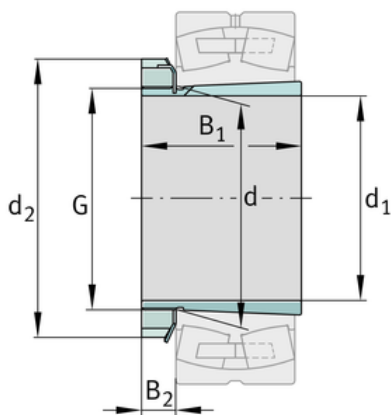
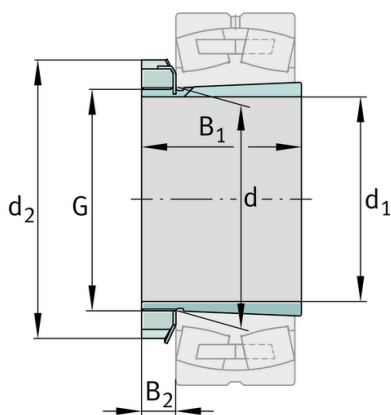
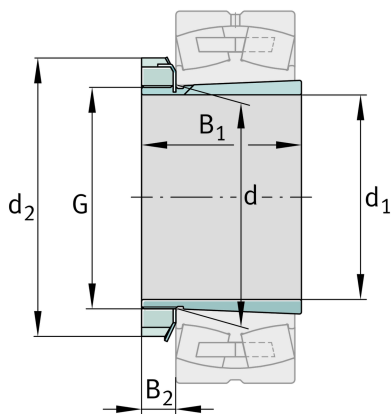
**FAG****H220**

Adapter sleeve

Schaeffler ID:
0167306820000Adapter sleeve H, accessory rolling
bearing, complete, mechanical, FP

Technical information

**Dimensions**

d	100 mm	Bore diameter bearing
d ₂	130 mm	Outside diameter nut
B ₂	19,75 mm	Width nut and lock
	1,608 kg	Weight

Main Dimensions & Performance Data

d ₁	90 mm	bore diameter
G	M100x2	Thread
B ₁	58 mm	sleeve length

Additional information

	KM20	Locknut
	MB20	Fuse
	1:12	Taper

