



FAG

H218

Adapter sleeve

Schaeffler ID:
0167306660000Adapter sleeve H, accessory rolling
bearing, complete, mechanical, FP

Technical information

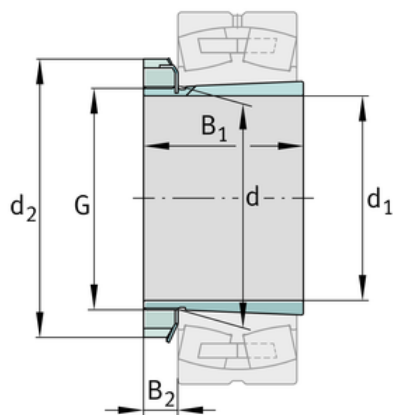
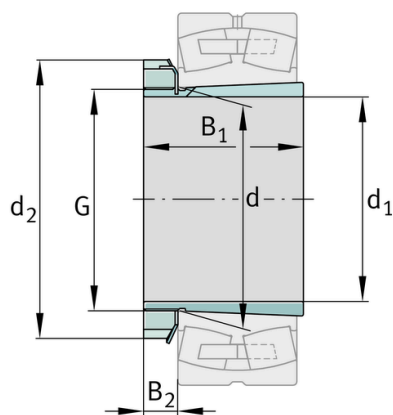
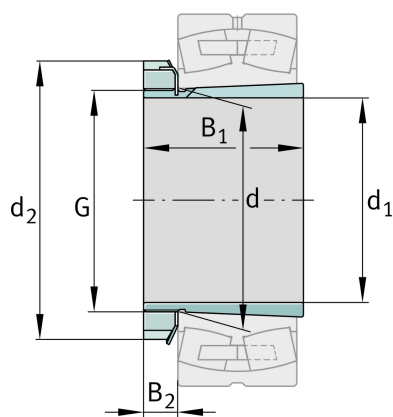
**Dimensions**

d	90 mm	Bore diameter bearing
d ₂	120 mm	Outside diameter nut
B ₂	17,75 mm	Width nut and lock
	1,23 kg	Weight

Main Dimensions & Performance Data

d ₁	80 mm	bore diameter
G	M90x2	Thread
B ₁	52 mm	sleeve length

Additional information

	KM18	Locknut
	MB18	Fuse
	1:12	Taper

