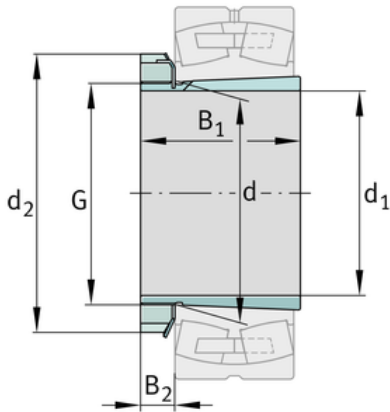
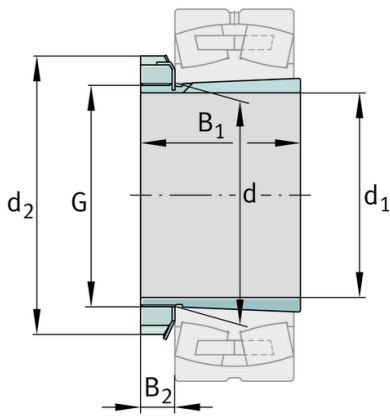
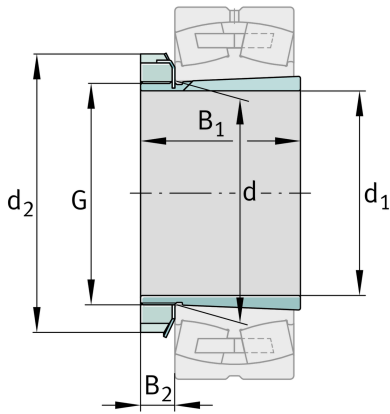
**FAG****H209****Adapter sleeve**Schaeffler ID:
0167305770000Adapter sleeve H, accessory rolling
bearing, complete, mechanical, FP

Technical information

**Dimensions**

d	45 mm	Bore diameter bearing
d ₂	65 mm	Outside diameter nut
B ₂	11,25 mm	Width nut and lock
	0,233 kg	Weight

Main Dimensions & Performance Data

d ₁	40 mm	bore diameter
G	M45x1,5	Thread
B ₁	33 mm	sleeve length

Additional information

	KM9	Locknut
	MB9	Fuse
	1:12	Taper

