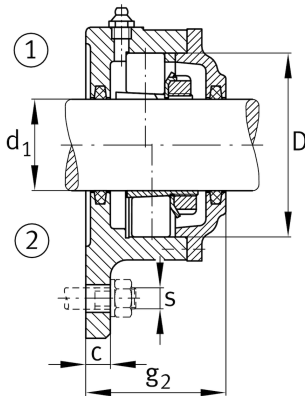
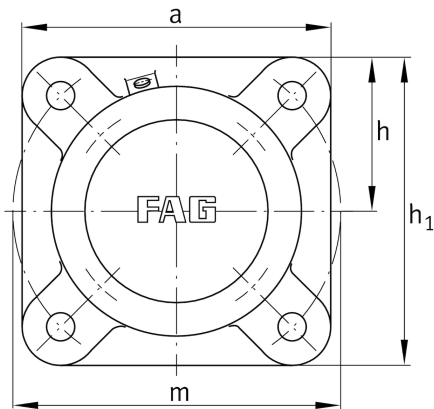

**FAG****F520-B-L**

Flanged housing

Schaeffler ID:
0384387980000Flanged housing for various bearing types,
with conical bore and clamping sleeve,
continuous shaft

Technical information

**Dimensions**

	M10x1	connection thread lubrication
c	30 mm	thickness of flange
D	180 mm	outside diameter bearing
g ₄	29 mm	distance flange to bearing seat
h	125 mm	distance shaft axis
m	280 mm	pitch circle diameter fixing holes
s	M20	size of fixing screws
	17,9 kg	Weight

Main Dimensions & Performance Data

d ₁	90 mm	Shaft diameter
a	250 mm	Flange width
h ₁	250 mm	height flange
g ₂	127 mm	total width with cover
	4	number of fastening holes