

**FAG****F513-WA-L**

Flanged housing

Schaeffler ID:
0383830390000

Flanged housing for various bearing types, wide version with conical bore and clamping sleeve, closed on one side

Technical information

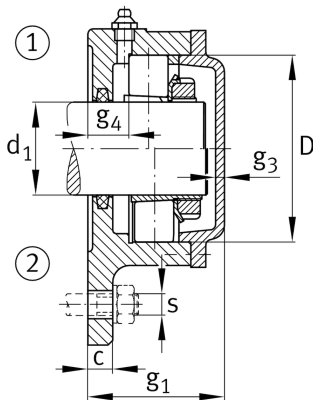
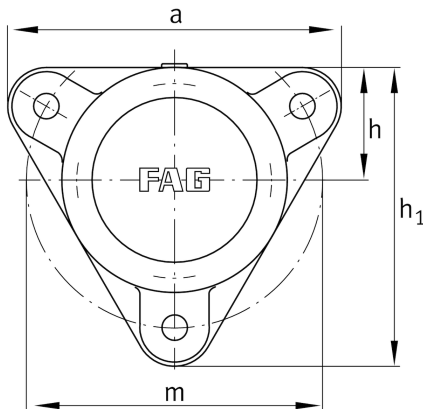
**Dimensions**

	M10x1	connection thread lubrication
c	16 mm	thickness of flange
D	120 mm	outside diameter bearing
g ₄	24 mm	distance flange to bearing seat
h	75 mm	distance shaft axis
m	190 mm	pitch circle diameter fixing holes
s	M12	size of fixing screws
	5,6 kg	Weight

Main Dimensions & Performance Data

d ₁	60 mm	Shaft diameter
a	219 mm	Flange width
h ₁	198 mm	height flange
g ₂	83 mm	total width with cover
	3	number of fastening holes