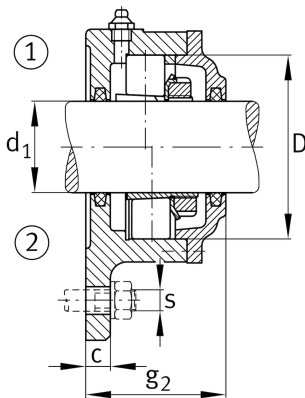
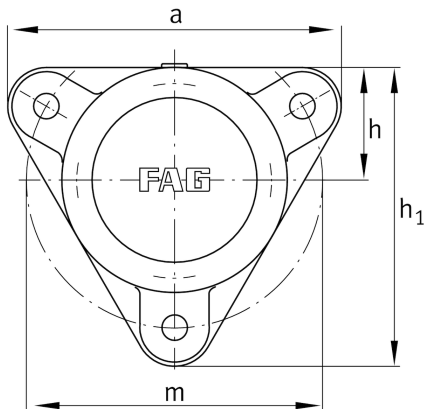

**FAG****F510-B-L**

Flanged housing

Schaeffler ID:
0384387040000Flanged housing for various bearing types,
with conical bore and clamping sleeve,
continuous shaft

Technical information

**Dimensions**

	M10x1	connection thread lubrication
c	15 mm	thickness of flange
D	90 mm	outside diameter bearing
g ₄	20 mm	distance flange to bearing seat
h	60 mm	distance shaft axis
m	160 mm	pitch circle diameter fixing holes
s	M12	size of fixing screws
	3,259 kg	Weight

Main Dimensions & Performance Data

d ₁	45 mm	Shaft diameter
a	180 mm	Flange width
h ₁	160 mm	height flange
g ₂	70 mm	total width with cover
	3	number of fastening holes