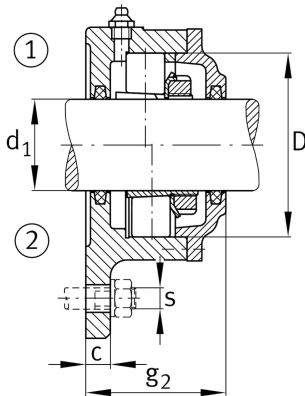
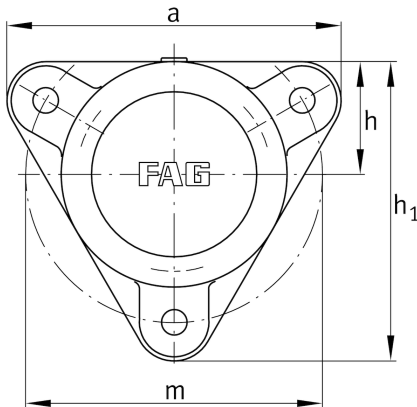

**FAG****F506-B-L**

Flanged housing

Schaeffler ID:  
0384386310000Flanged housing for various bearing types,  
with conical bore and clamping sleeve,  
continuous shaft

## Technical information

**Dimensions**

	M10x1	connection thread lubrication
c	12 mm	thickness of flange
D	62 mm	outside diameter bearing
g <sub>4</sub>	18 mm	distance flange to bearing seat
h	44 mm	distance shaft axis
m	116 mm	pitch circle diameter fixing holes
s	M10	size of fixing screws
	1,6 kg	Weight

**Main Dimensions & Performance Data**

d <sub>1</sub>	25 mm	Shaft diameter
a	130 mm	Flange width
h <sub>1</sub>	117 mm	height flange
g <sub>2</sub>	57 mm	total width with cover
	3	number of fastening holes