



Technical data

UCF212 Bearing units

Grey cast housing, radial insert ball bearing with socket set screws, seal with slinger

KIT CONTENT

UC212G2, F212

VISUAL (S)

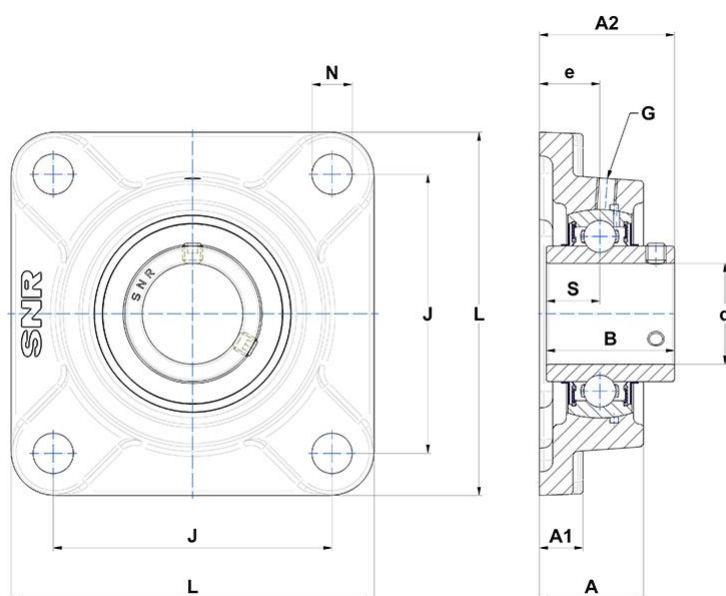

PRODUCT DIMENSIONS

Housing height (A)	48 mm
Housing foot height / flange height (A1)	18 mm
Total height (Housing + Insert) from mounting surface (A2)	68,7 mm
Width of IR (B)	65,1 mm
Shaft dia (d)	60 mm
Distance mounting surface - bearing center (e)	29 mm

PRODUCT DIMENSIONS

Grease fitting (G)	M6x1
Mounting hole distance (J)	143 mm
Housing width / dia (L)	175 mm
Mounting hole dimension (N)	19 mm
Dist. cent. of raceway to face IR on side opp. lock. device (S)	25,4 mm
Brand	SNR

OTHER FEATURES

Mass	4,36 kg
Recommended tightening torque for set screw [Nm]	22.0 N-m

PRODUCT PERFORMANCE

Dynamic load rating (C)	52,5 kN
Static load rating (C0)	32,8 kN
Operating temperature min.	-20 °C
Operating temperature max.	100 °C