



## Technical data

51205

One direction thrust ball bearings

### VISUAL (S)

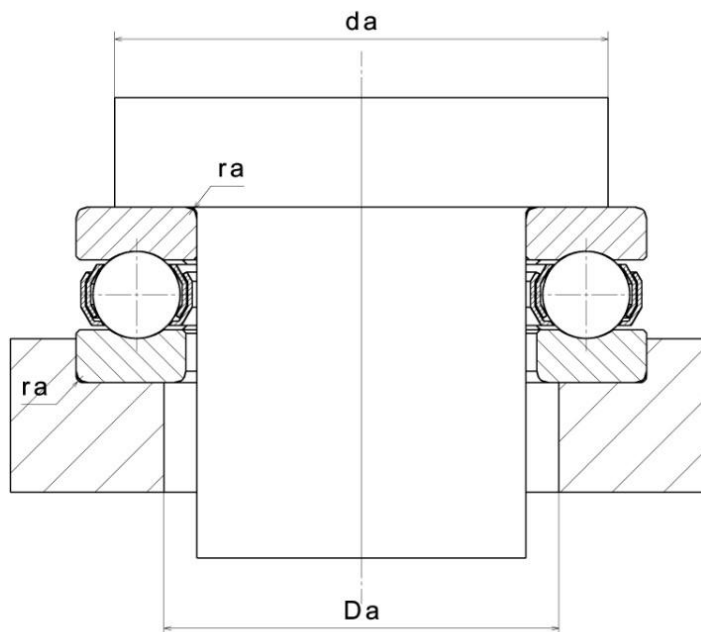
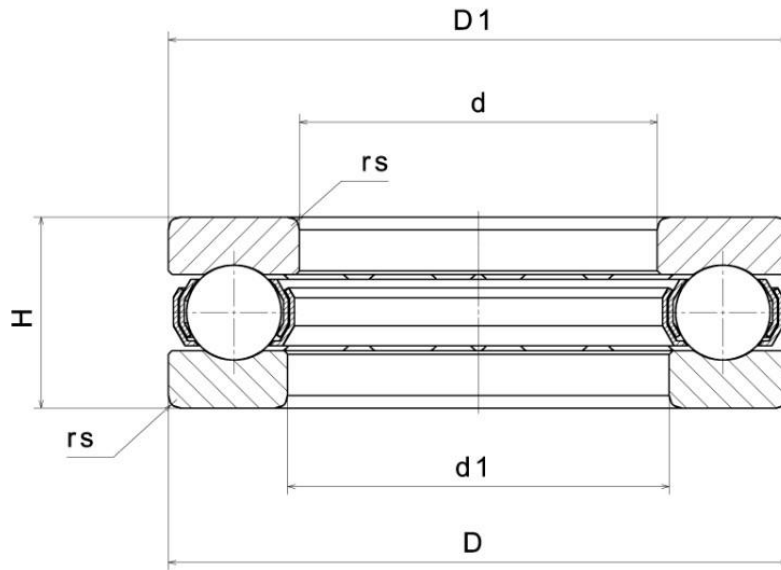

## PRODUCT DIMENSIONS

<b>Internal diameter (d)</b>	25 mm
<b>External diameter (D)</b>	47 mm
<b>Inner diameter outer ring (D1)</b>	27 mm
<b>External diameter inner ring d1</b>	47 mm
<b>Thrust bearing height (T)</b>	15 mm
<b>Min fillet radius (rs)</b>	0,6 mm
<b>Mass</b>	0,11 kg

## PRODUCT PERFORMANCE

<b>Dynamic axial load rating (Ca)</b>	27,8 kN
<b>Static axial load rating (C0a)</b>	50,5 kN
<b>Min operating temperature (Tmin)</b>	-40 °C
<b>Max operating temperature (Tmax)</b>	120 °C

## ABUTMENT

<b>Max shaft &amp; housing fillet radius (ra max)</b>	0,6 mm
<b>Max shoulder diameter OR (Da max)</b>	34 mm
<b>Min shoulder diameter IR (da min)</b>	38 mm