

Technical data

6310ZZC3/5K

Single row deep groove ball bearings

Deep groove ball bearing, radial contact, pressed steel cage, shields on both sides

VISUAL (S)

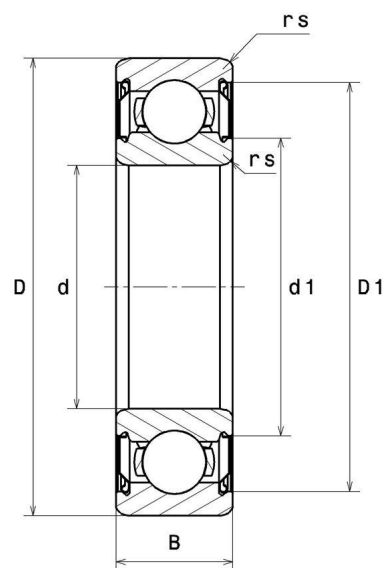
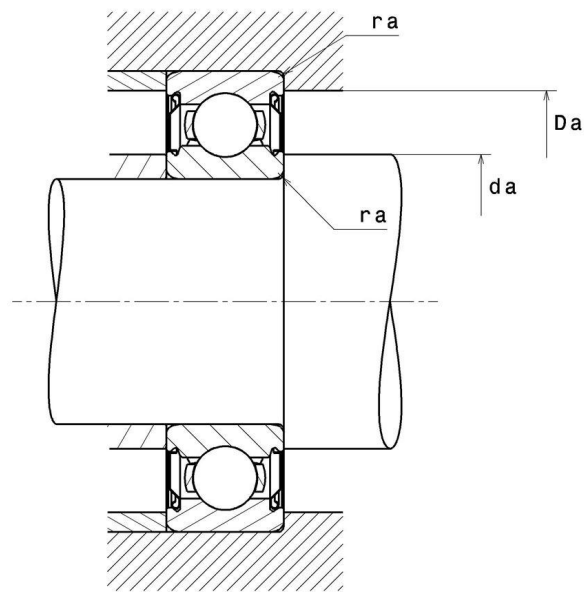

6310ZZC3/5K

Single row deep groove ball bearings

PRODUCT DIMENSIONS

Internal diameter (d)	50 mm
External diameter (D)	110 mm
Bearing/Inner ring width (B)	27 mm
Min fillet radius (rs)	2 mm
Radial clearance class	C3
Mass	1,07 kg
Brand	NTN

PRODUCT PERFORMANCE

Dynamic load (C)	68,5 kN
Static load (C0)	38,5 kN
Fatigue limit load (Cu)	2,99 kN
Coefficient f0	13.2
Nlim (grease)	6400 tr/min
Min operating temperature (Tmin)	-40 °C
Max operating temperature (Tmax)	150 °C

ABUTMENT

Min shoulder diameter IR (da min)	59 mm
Max shoulder diameter OR (Da max)	101 mm
Max shaft & housing fillet radius (ra max)	2 mm

INDUSTRY CALCUL FACTORS

Equivalent dynamic radial load

$$P = X.F_r + Y.F_a$$

$\frac{f_0 F_a}{C_0}$	e	Fa / Fr ≤ e		Fa / Fr > e	
		X	Y	X	Y
0.172	0.19	1	0	0.56	2.3
0.345	0.22				1.99
0.689	0.26				1.71
1.03	0.28				1.55
1.38	0.3				1.45
2.07	0.34				1.31
3.45	0.38				1.15
5.17	0.42				1.04
6.89	0.44				1

Equivalent static radial load

$$P_0 = X_0.F_r + Y_0.F_a$$

X_0	Y_0
0.6	0.5

For single or DT bearing arrangement:

If $P_0 < F_r$, then use $P_0 = F_r$