



Technical data

6204LLUC3/5K

Single row deep groove ball bearings

Deep groove ball bearing, radial contact, pressed steel cage, contact seals on both sides

VISUAL (S)

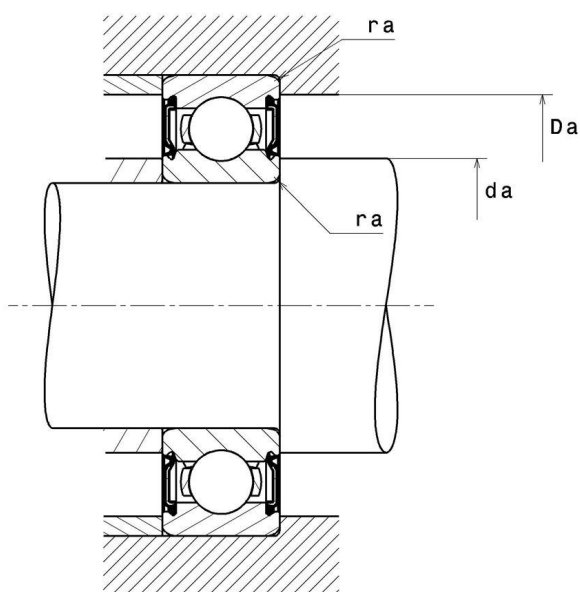
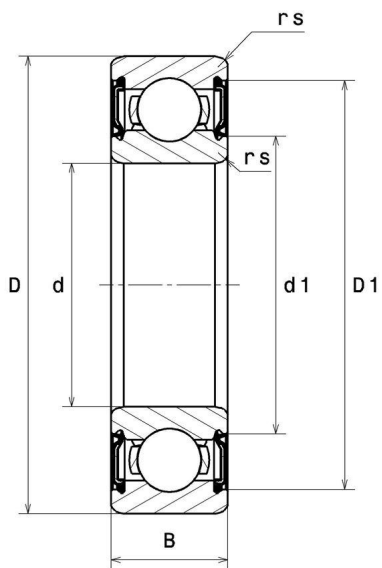

6204LLUC3/5K

Single row deep groove ball bearings

PRODUCT DIMENSIONS

Internal diameter d	20 mm
External diameter D	47 mm
Bearing/Inner ring width(B)	14 mm
Min fillet radius rs	1 mm
Radial clearance class	C3
Mass	0,106 kg
Brand	NTN

PRODUCT PERFORMANCE

Dynamic load, C	14,2 kN
Static load, C0	6,65 kN
Fatigue limit load, Cu	0,505 kN
Coefficient f0	13.2
Nlim (grease)	10000 tr/min
Min operating temperature, Tmin	-25 °C
Max operating temperature, Tmax	110 °C
Characteristic cage frequency, FTF	0.385 Hz
Characteristic rolling element frequency, BSF	4.116 Hz
Characteristic outer ring frequency, BPF0	3.08 Hz
Characteristic inner ring frequency, BPF1	4.92 Hz

ABUTMENT

Min shoulder diameter IR da min	25 mm
Max shoulder diameter IR da max	28 mm
Max shoulder diameter OR Da max	42 mm
Max shaft & housing fillet radius ra max	1 mm

INDUSTRY CALCUL FACTORS

Equivalent dynamic radial load

$$P = X.F_r + Y.F_a$$

$\frac{f_0 F_a}{C_0}$	e	Fa / Fr ≤ e		Fa / Fr > e	
		X	Y	X	Y
0.172	0.19	1	0	0.56	2.3
0.345	0.22				1.99
0.689	0.26				1.71
1.03	0.28				1.55
1.38	0.3				1.45
2.07	0.34				1.31
3.45	0.38				1.15
5.17	0.42				1.04
6.89	0.44				1

Equivalent static radial load

$$P_0 = X_0.F_r + Y_0.F_a$$

X_0	Y_0
0.6	0.5

For single or DT bearing arrangement:

If $P_0 < F_r$, then use $P_0 = F_r$