



**Technical data**

**6201ZZC3/5K**

Single row deep groove ball bearings

Deep groove ball bearing, radial contact, pressed steel cage, shields on both sides

**VISUAL (S)**

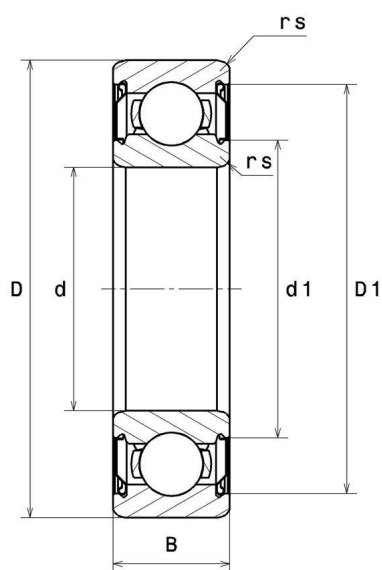
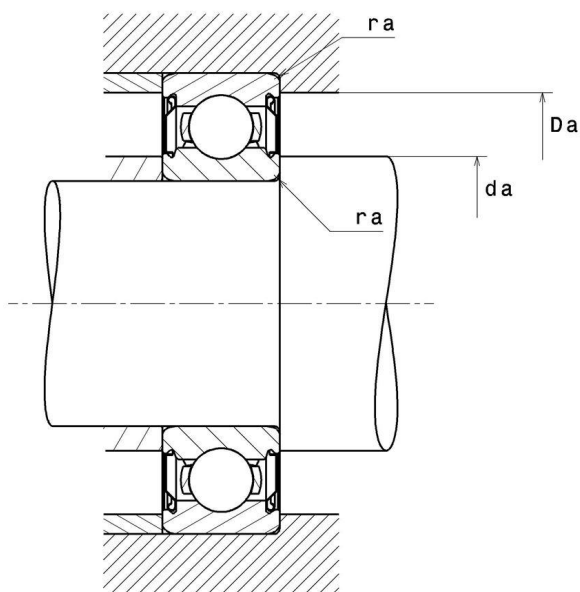

# 6201ZZC3/5K

Single row deep groove ball bearings

## PRODUCT DIMENSIONS

<b>Internal diameter d</b>	12 mm
<b>External diameter D</b>	32 mm
<b>Bearing/Inner ring width(B)</b>	10 mm
<b>Min fillet radius rs</b>	0,6 mm
<b>Radial clearance class</b>	C3
<b>Mass</b>	0,037 kg
<b>Brand</b>	NTN

## PRODUCT PERFORMANCE

<b>Dynamic load, C</b>	6,75 kN
<b>Static load, C0</b>	2,75 kN
<b>Fatigue limit load, Cu</b>	0,214 kN
<b>Coefficient f0</b>	12.7
<b>Nlim (grease)</b>	22000 tr/min
<b>Min operating temperature, Tmin</b>	-40 °C
<b>Max operating temperature, Tmax</b>	150 °C
<b>Characteristic cage frequency, FTF</b>	0.374 Hz
<b>Characteristic rolling element frequency, BSF</b>	3.707 Hz
<b>Characteristic outer ring frequency, BPF0</b>	2.616 Hz
<b>Characteristic inner ring frequency, BPF1</b>	4.384 Hz

## ABUTMENT

<b>Min shoulder diameter IR da min</b>	16 mm
<b>Max shoulder diameter OR Da max</b>	28 mm
<b>Max shaft &amp; housing fillet radius ra max</b>	0,6 mm

# 6201ZZC3/5K

Single row deep groove ball bearings

## INDUSTRY CALCUL FACTORS

### Equivalent dynamic radial load

$$P = X.F_r + Y.F_a$$

$\frac{f_0 F_a}{C_0}$	e	Fa / Fr ≤ e		Fa / Fr > e	
		X	Y	X	Y
0.172	0.19	1	0	0.56	2.3
0.345	0.22				1.99
0.689	0.26				1.71
1.03	0.28				1.55
1.38	0.3				1.45
2.07	0.34				1.31
3.45	0.38				1.15
5.17	0.42				1.04
6.89	0.44				1

### Equivalent static radial load

$$P_0 = X_0.F_r + Y_0.F_a$$

$X_0$	$Y_0$
0.6	0.5

For single or DT bearing arrangement:

If  $P_0 < F_r$ , then use  $P_0 = F_r$