

Technical data

6012ZZC3/5K

Single row deep groove ball bearings

Deep groove ball bearing, radial contact, pressed steel cage, shields on both sides

VISUAL (S)

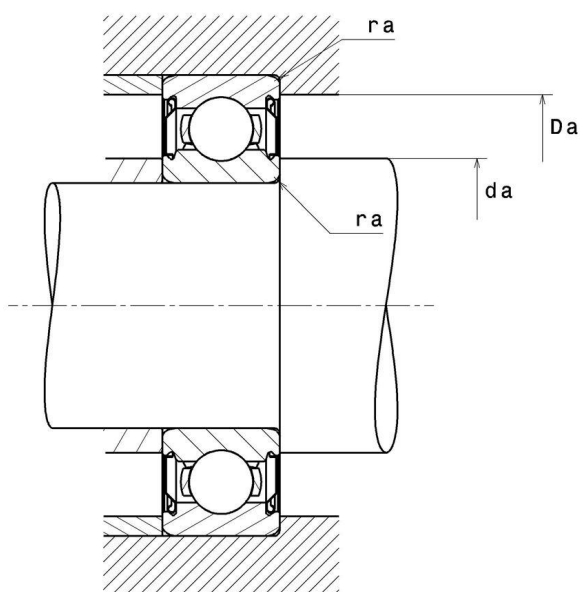
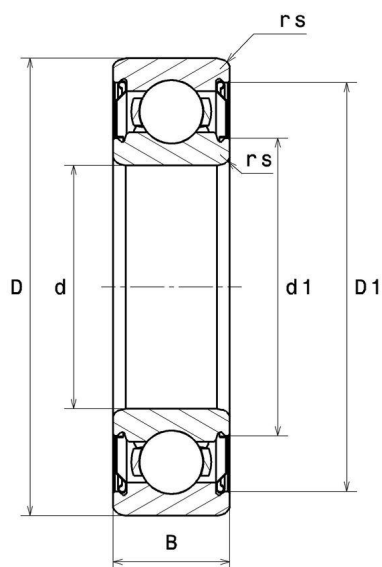

6012ZZC3/5K

Single row deep groove ball bearings

PRODUCT DIMENSIONS

Internal diameter d	60 mm
External diameter D	95 mm
Bearing/Inner ring width(B)	18 mm
Min fillet radius rs	1,1 mm
Radial clearance class	C3
Mass	0,414 kg
Brand	NTN

PRODUCT PERFORMANCE

Dynamic load, C	32,5 kN
Static load, C0	23,2 kN
Fatigue limit load, Cu	1,73 kN
Coefficient f0	15.6
Nlim (grease)	7000 tr/min
Min operating temperature, Tmin	-40 °C
Max operating temperature, Tmax	150 °C
Characteristic cage frequency, FTF	0.433 Hz
Characteristic rolling element frequency, BSF	7.377 Hz
Characteristic outer ring frequency, BPF0	6.068 Hz
Characteristic inner ring frequency, BPF1	7.932 Hz

ABUTMENT

Min shoulder diameter IR da min	66,5 mm
Max shoulder diameter OR Da max	88,5 mm
Max shaft & housing fillet radius ra max	1 mm

6012ZZC3/5K

Single row deep groove ball bearings

INDUSTRY CALCUL FACTORS

Equivalent dynamic radial load

$$P = X.F_r + Y.F_a$$

$\frac{f_0 F_a}{C_0}$	e	Fa / Fr ≤ e		Fa / Fr > e	
		X	Y	X	Y
0.172	0.19	1	0	0.56	2.3
0.345	0.22				1.99
0.689	0.26				1.71
1.03	0.28				1.55
1.38	0.3				1.45
2.07	0.34				1.31
3.45	0.38				1.15
5.17	0.42				1.04
6.89	0.44				1

Equivalent static radial load

$$P_0 = X_0.F_r + Y_0.F_a$$

X_0	Y_0
0.6	0.5

For single or DT bearing arrangement:

If $P_0 < F_r$, then use $P_0 = F_r$