

FAG

## ★ 6204-C-2HRS

Deep groove ball bearing

Schaeffler ID:  
0621565860000

★ Preferred product

Deep groove ball bearing 62...-C-2HRS,  
single row, Generation C, seals, steel  
sheet metal cage

## Technical information

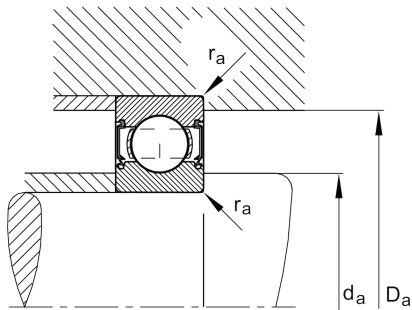
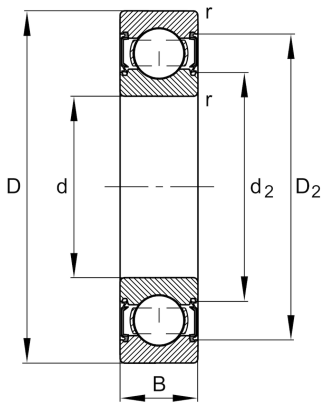

## Temperature range

$T_{\min}$	-20 °C	Operating temperature min.
$T_{\max}$	110 °C	Operating temperature max.
	0,102 kg	Weight

## Main Dimensions &amp; Performance Data

d	20 mm	Bore diameter
D	47 mm	Outside diameter
B	14 mm	Width
$C_r$	14.700 N	Basic dynamic load rating, radial
$C_{0r}$	6.600 N	Basic static load rating, radial
$C_{ur}$	455 N	Fatigue load limit, radial
$n_G$	14.500 1/min	Limiting speed

## Dimensions

$r_{\min}$	1 mm	Minimum chamfer dimension
$D_2$	41,4 mm	Caliber diameter outer ring
$d_2$	26,6 mm	Caliber diameter inner ring

## Mounting dimensions

$d_{a\min}$	25,6 mm	Minimum diameter shaft shoulder
$D_{a\max}$	41,4 mm	Maximum diameter of housing shoulder
$r_{a\max}$	1 mm	Maximum fillet radius

## Calculation factors

$f_0$	13,1	Calculation factor
-------	------	--------------------