



FAG

★ 6201-C-2Z

Deep groove ball bearing

Schaeffler ID:
0593716680000

Deep groove ball bearing 62...-C-2Z, single row, Generation C, shields, steel sheet metal cage

★ Preferred product

Technical information

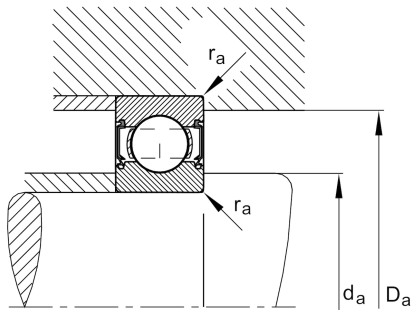
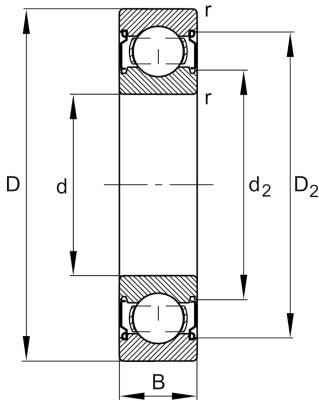

Temperature range

T_{\min}	-20 °C	Operating temperature min.
T_{\max}	120 °C	Operating temperature max.
	0,036 kg	Weight

Main Dimensions & Performance Data

d	12 mm	Bore diameter
D	32 mm	Outside diameter
B	10 mm	Width
C_r	8.000 N	Basic dynamic load rating, radial
C_{0r}	3.100 N	Basic static load rating, radial
C_{ur}	213 N	Fatigue load limit, radial
n_G	31.500 1/min	Limiting speed
n_{gr}	24.600 1/min	Reference speed

Dimensions

r_{\min}	0,6 mm	Minimum chamfer dimension
D_2	27,9 mm	Caliber diameter outer ring
d_2	17,2 mm	Caliber diameter inner ring

Mounting dimensions

$d_{a\min}$	16,2 mm	Minimum diameter shaft shoulder
$D_{a\max}$	27,8 mm	Maximum diameter of housing shoulder
$r_{a\max}$	0,6 mm	Maximum fillet radius

Calculation factors

f_0	12,3	Calculation factor
-------	------	--------------------